

# MESSINGSCHLÜSSEL BRÜNIERT

ALLES FÜR DEN SCHLÜSSELDIENST

Gradbart 8 x 8 mm – Halmstärke 6 mm = normal

Gradbart 6 x 6 mm – Halmstärke 5 mm = zierlich



B 1701 / 30 + 40 mm



B 1702 / 30,35,40+45  
B 1702 / 35 zierlich



B 1705 / 30 + 40 mm



B 1717 / 30 + 40 mm  
B 1717 / 35 zierlich



B 1718 / 33 + 42 mm



B 1719 / 33 mm



B 1720 / 30,35+40  
B 1720 / 30 zierlich



B 1722 / 32 + 42 mm



B 1723 / 30,35,40+45  
B 1723 / 30 zierlich



B 1724 / 33 + 42 mm



B 1725 / 33 mm



B 1726 / 32 + 42 mm



B 1727 / 30 + 40 mm



B 1728 / 35 + 45 mm



B 1729 / 32 mm



B 1730 / 32 + 42 mm



B 1737 / 42 mm  
KLAPPRING



B 1731 / 35 mm



B 1732 / 32 + 42 mm



DB 1720 / 45 mm  
Gradbart 13x10 mm  
Halm 6 mm durchgeh.

# MESSINGSCHLÜSSEL POLIERT

ALLES FÜR DEN SCHLÜSSELDIENST

Gradbart 8 x 8 mm – Halmstärke 6 mm = normal

Gradbart 6 x 6 mm – Halmstärke 5 mm = zierlich



1701 / 30 + 40 mm



1702 / 30,35,40+45  
1702 / 35 zierlich



1704 / 40 mm



1705 / 30 + 40 mm



1709 / 35 + 45 mm

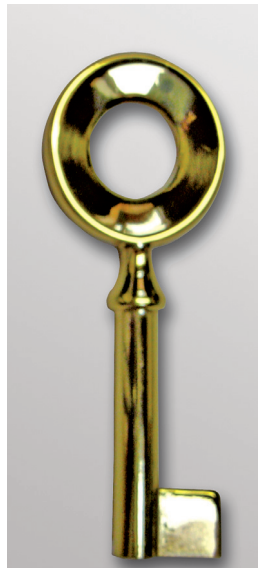

1710 / 30,40+45 mm  
1710 / 35 zierlich



1713 / 30 + 35 mm



1715 / 35 + 40 mm



1717 / 30 + 40 mm



1719 / 33 mm

Gradbart 8 x 8 mm – Halmstärke 6 mm = normal

Gradbart 6 x 6 mm – Halmstärke 5 mm = zierlich



1720 / 30,35 + 40 mm  
1720 / 30 zierlich



1722 / 32 + 42 mm



1723 / 30,35,40+45 mm  
1723 / 30 zierlich



1724 / 33 mm



1730 / 32 + 42 mm



1732 / 32 + 42 mm



1735 / 42 mm



D 1717 / 45 mm  
Gradbart 13x10 mm  
Halm 6 mm durchgeh.



D 1720 / 45 mm  
Gradbart 13x10 mm  
Halm 6 mm durchgeh.



D 1736 / 45 mm  
Gradbart 13x10 mm  
Halm 6 mm durchgeh.

# MESSINGSCHLÜSSEL VERNICKELT

ALLES FÜR DEN SCHLÜSSELDIENST

Gradbart 8 x 8 mm – Halmstärke 6 mm = normal

Gradbart 6 x 6 mm – Halmstärke 5 mm = zierlich



1709 N/35 + 45 mm



1710 N/ 30,40 + 45 mm  
1710 N/ 35 zierlich



1713 N/30 + 35 mm



1715 N/35 + 40 mm



1720 N/ 30,35 + 40 mm



1735 N/ 42 mm

## Achtung!

Brünierte  
Messingschlüssel  
siehe Seite 1 und 2

**Ausführung BW mit  
Bienenwachs-Auflage  
in brüniertes-patiniertes  
Optik.**

Jeder Schlüssel in einen  
individuellen Färbung.

Mit einem Wolltuch  
abgerieben haben die  
Schlüssel einen  
Alt-Messing-Glanz!

# MESSINGSCHLÜSSEL ANTIK



BW 1701 / 40 mm



BW 1702 / 30,35 + 40



BW 1720 / 30,35 + 40

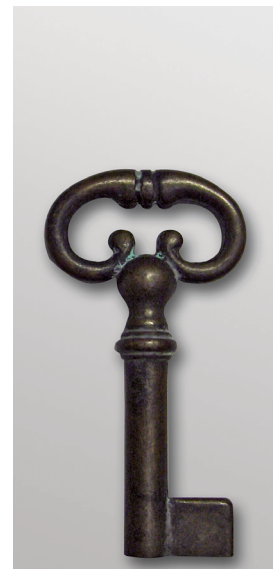

BW 1723 / 30,35 + 40

# Messing Möbelschlüssel Art.Nr. 600 -...

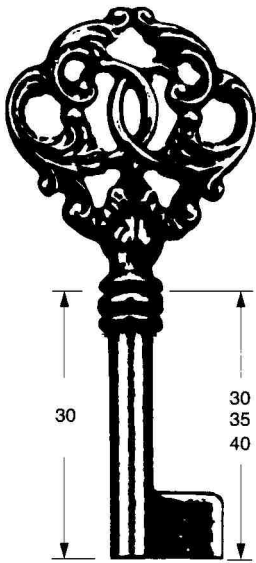

Art. Nr. 600/16	
5 mm	6 mm
x	x
x	x
	x
	x

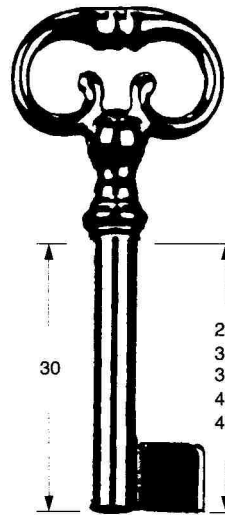

AS = 30,35,40 ø6mm

Art. Nr. 600/26	
5 mm	6 mm
x	x
x	x
	x

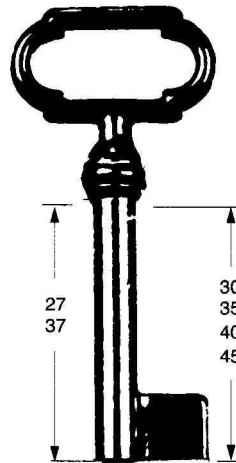

Art. Nr. 600/33	
5 mm	6 mm
x	x
x	x
	x

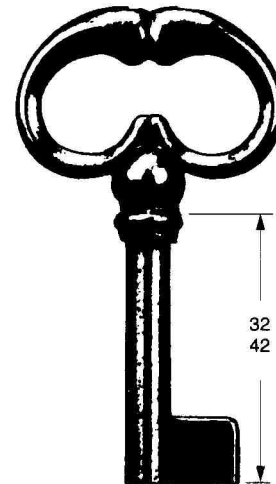

Art. Nr. 600/30		Artikelnr.
5 mm	6 mm	
	x	Ausführung ( Halmstärke )
		Messing poliert (M)
	x	Messing Altdeutsch (AD)
		Messing Brüniert (B)
		Messing Vernickelt (N)
		Messing Schwarz gefärbt (S)
x		Messing Altsilber (AS)

Bitte Artikel immer mit Artikelnummer, Färbung, Halmlänge und Halmstärke bei der Bestellung angeben.  
z.B. : 600/16 M 35x6 mm ist der Art. 600/16 in Färbung Messing poliert, Halmlänge 35mm, Halmstärke 6mm

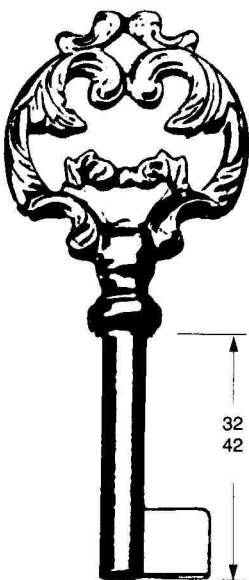

Art. Nr. 600/25	
5 mm	6 mm
	x
	x

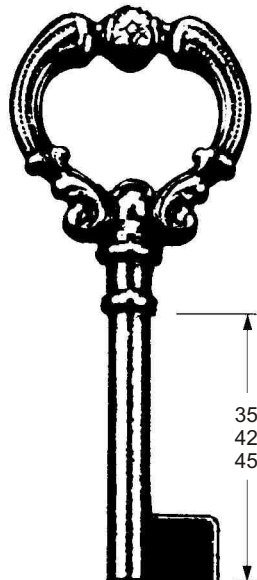

AD = 35,45  
M = 35,42

Art. Nr. 600/49	
5 mm	6 mm
	x
	x



Art. Nr. 600/43	
5 mm	6 mm
	x
	x

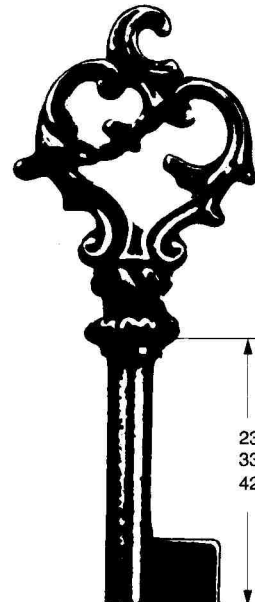

Art. Nr. 600/29		Artikelnr.
5 mm	6 mm	
	x	Ausführung ( Halmstärke )
		Messing poliert (M)
		Messing Altdeutsch (AD)
x		Messing Brüniert (B)

Bitte Artikel immer mit Artikelnummer, Färbung, Halmlänge und Halmstärke bei der Bestellung angeben.  
z.B. : 600/16 M 35x6 mm ist der Art. 600/16 in Färbung Messing poliert, Halmlänge 35mm, Halmstärke 6mm

# Messing Möbelschlüssel Art.Nr. 600 -...

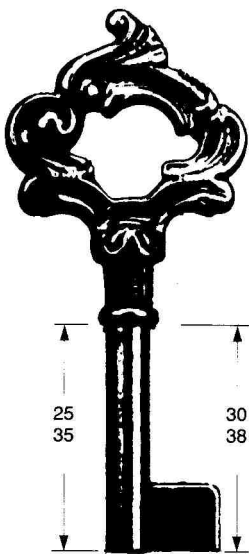

Art. Nr. 600/17	
5 mm	6 mm
x	x
x	x

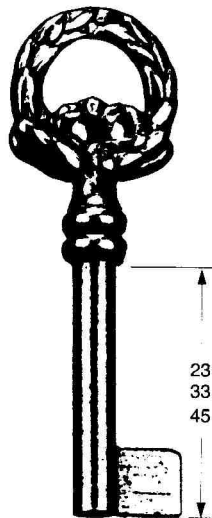

M = 23,33 mm  
AD = 23,33,45 mm

Art. Nr. 600/44	
5 mm	6 mm
	x
	x

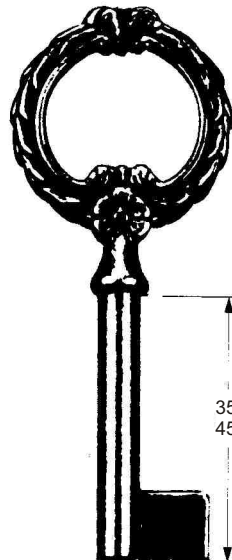

M = 35 mm  
AD = 35,45 mm

Art. Nr. 600/41	
5 mm	6 mm
	x
	x

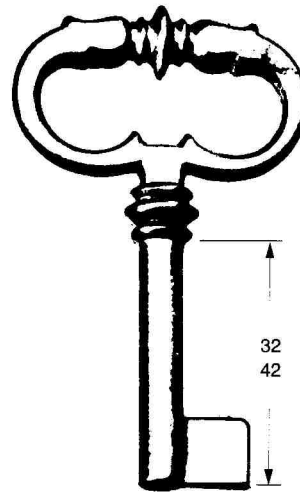

Art. Nr. 600/12		Artikelnr.
5 mm	6 mm	Ausführung ( Halmstärke )
	x	Messing poliert (M)
		Messing Altdeutsch (AD)
		Messing Brüniert (B)

Bitte Artikel immer mit Artikelnummer, Färbung, Halmlänge und Halmstärke bei der Bestellung angeben.  
z.B. : **600/16 M 35x6 mm** ist der Art. 600/16 in Färbung Messing poliert, Halmlänge 35mm, Halmstärke 6mm

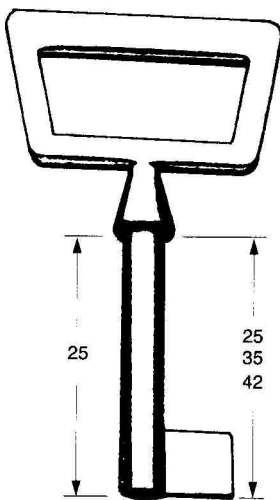

S = 25 mm

Art. Nr. 600/59	
5 mm	6 mm
x	x
	x
	x

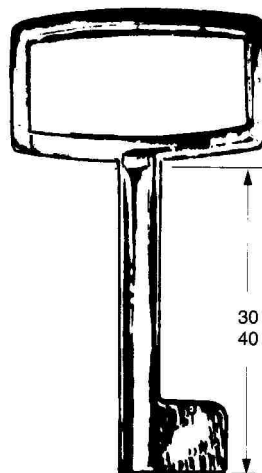

S = 40 ø6mm

Art. Nr. 600/82	
5 mm	6 mm
	x
	x
	x
	x

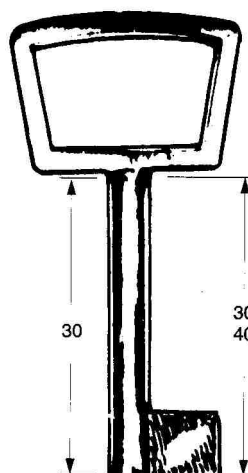

Art. Nr. 600/83	
5 mm	6 mm
x	x
	x
	x
	x

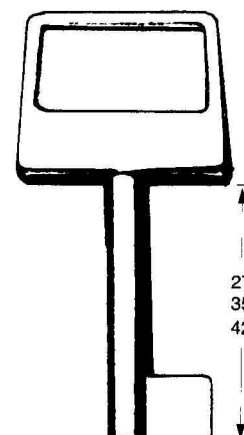

S = 35,42

Art. Nr. 600/32		Artikelnr.
5 mm	6 mm	Ausführung ( Halmstärke )
	x	Messing poliert (M)
		Messing Altdeutsch (AD)
		Messing Brüniert (B)
	x	Messing Vernickelt (N)
	x	Messing Schwarz gefärbt (S)

Bitte Artikel immer mit Artikelnummer, Färbung, Halmlänge und Halmstärke bei der Bestellung angeben.  
z.B. : **600/16 M 35x6 mm** ist der Art. 600/16 in Färbung Messing poliert, Halmlänge 35mm, Halmstärke 6mm

# Messing Möbelschlüssel Art.Nr. 600 -...

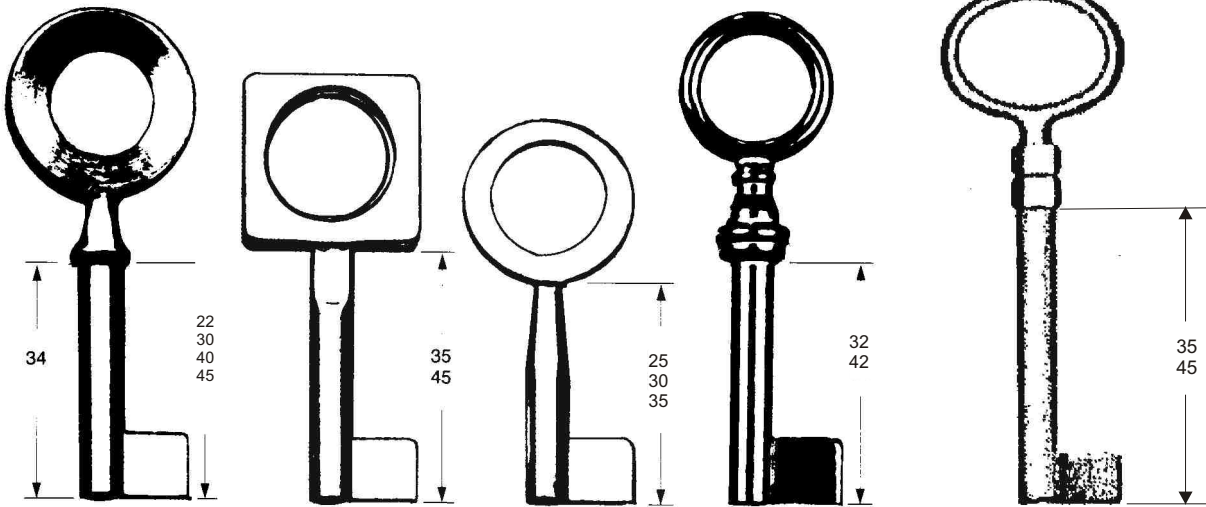

nur N = 22 mm ø6 mm

nur M = 25 mm

Art. Nr. 600/15	
5 mm	6 mm
x	x
x	x

Art. Nr. 600/56	
5 mm	6 mm
	x
	x

Art. Nr. 600/37	
5 mm	6 mm
	x
	x

Art. Nr. 600/48	
5 mm	6 mm
	x

Art. Nr. 600/55	Artikelnr.	
5 mm	6 mm	Ausführung ( Halmstärke )
	x	Messing poliert (M)
	x	Messing Altdeutsch (AD)
		Messing Brüniert (B)
		Messing Vernickelt (N)

Bitte Artikel immer mit Artikelnummer, Färbung, Halmlänge und Halmstärke bei der Bestellung angeben.  
z.B. : 600/16 M 35x6 mm ist der Art. 600/16 in Färbung Messing poliert, Halmlänge 35mm, Halmstärke 6mm

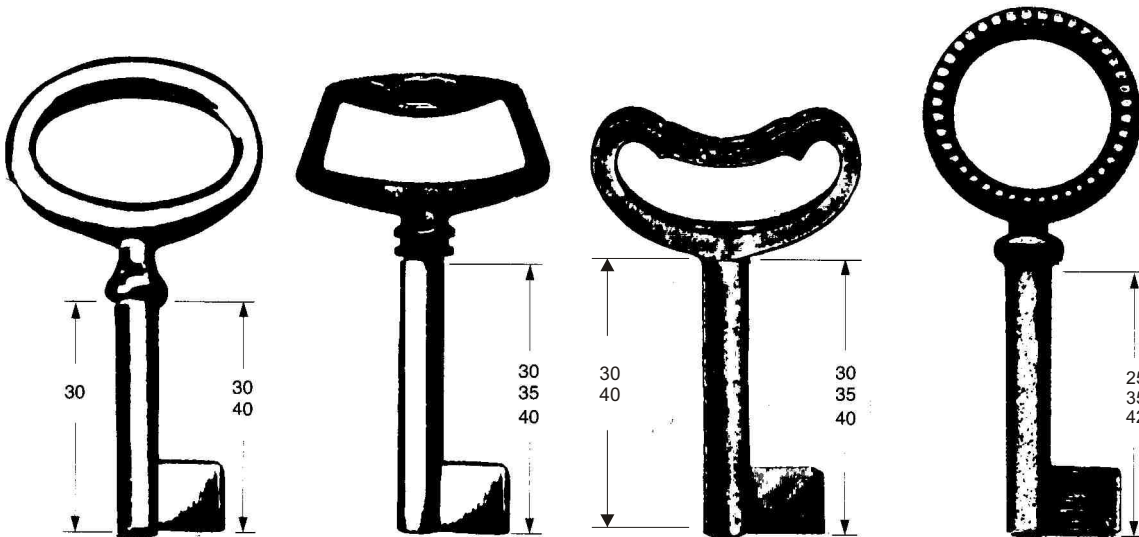

B = nur 30 mm

Art. Nr. 600/28	
5 mm	6 mm
x	x
x	x
	x

Art. Nr. 600/62	
5 mm	6 mm
	x
	x

Art. Nr. 600/50	
5 mm	6 mm
x	x
x	x

Art. Nr. 600/45	Artikelnr.	
5 mm	6 mm	Ausführung ( Halmstärke )
	x	Messing poliert (M)
	x	Messing Altdeutsch (AD)
		Messing Brüniert (B)
		Messing Vernickelt (N)
		Messing Schwarz gefärbt (S)

Bitte Artikel immer mit Artikelnummer, Färbung, Halmlänge und Halmstärke bei der Bestellung angeben.  
z.B. : 600/16 M 35x6 mm ist der Art. 600/16 in Färbung Messing poliert, Halmlänge 35mm, Halmstärke 6mm



**Messing Möbelschlüssel durchgehend Art.Nr. 600 D -...**  
**Halmstärke 6 mm ( Abb. 1:1 )**

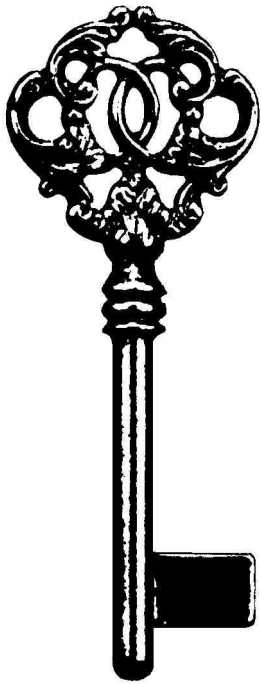

\* Art. 600/16D

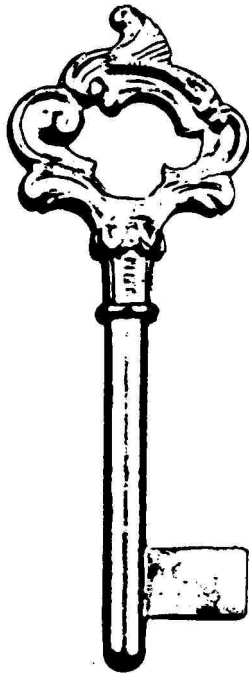

\* Art. 600/17D

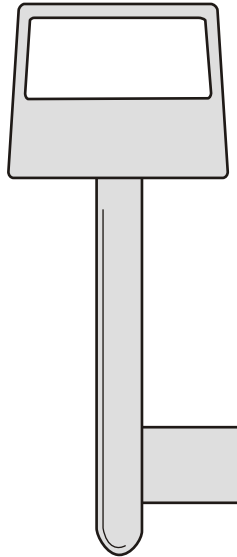

\* Art. 600/32 D  
nur in Messing

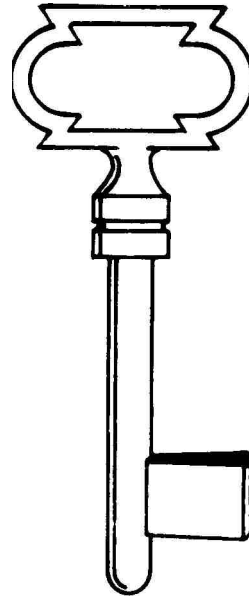

\* Art. 600/33D

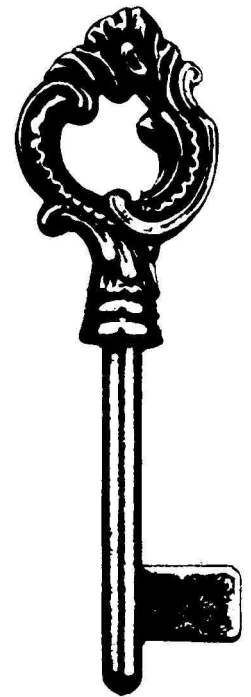

\* Art. 600/43D

\* lieferbar in Messing poliert (M) oder Messing Altdeutsch (AD)

**Bitte Färbung bei der Bestellung immer mit angeben.**  
Fehlt diese Angabe, so wird automatisch Messing poliert geliefert.