







Außentüren – H-Riegel

AS 2000

Mehrfachverriegelung mit Hauptschloss und 2 H-Riegeln
25 und 30 mm Dorn = AS 9200

Art. Nr.	Stulp	Maße
AS 2000 F 24		24 x 3 mm
AS 2000 P 6/24		6 x 24 x 6 x 2 mm

Entfernung	Dornmaß												in mm	
 92	-	-	-	35	40	45	-	-	-	-	-	-	-	-
	-	-	-	20	20	20	-	-	-	-	-	-	-	-
	8 mm, 10 mm													

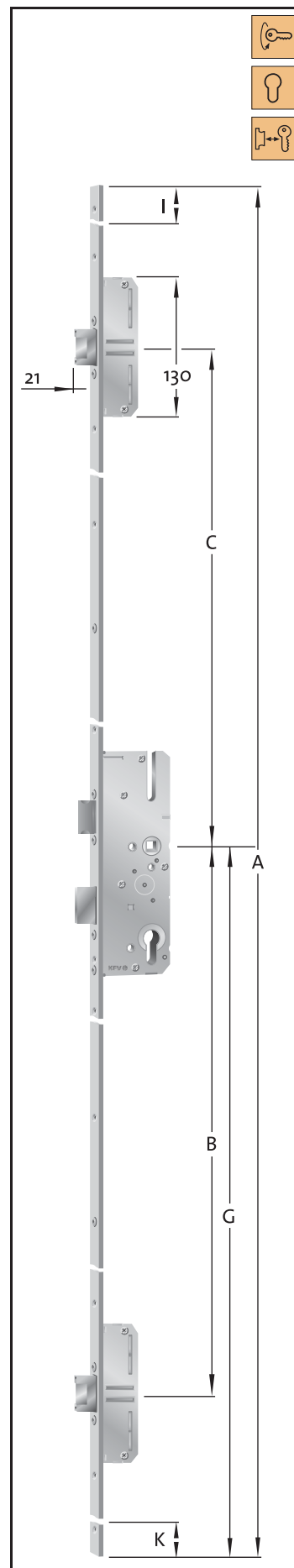

Varianten in mm							
		A	B	C	G	I	K
92 mm	Stand.	2170	760	730	1020	320	160







1
2
3
4
5
6
7
8
9

AS 9200

Mehrfachverriegelung mit Hauptschloss und 2 H-Riegeln

Art. Nr.	Stulp	Maße
AS 9200 F 24		24 x 3 mm
AS 9200 P 6/24		6 x 24 x 6 x 2 mm

Entfernung	Dornmaß												in mm	
 92	25	-	30	-	-	-	-	-	-	-	-	-	-	
	10	-	15	-	-	-	-	-	-	-	-	-	-	
	8 mm, 10 mm													

Varianten in mm							
		A	B	C	G	I	K
92 mm	Stand.	2170	760	730	1020	320	160

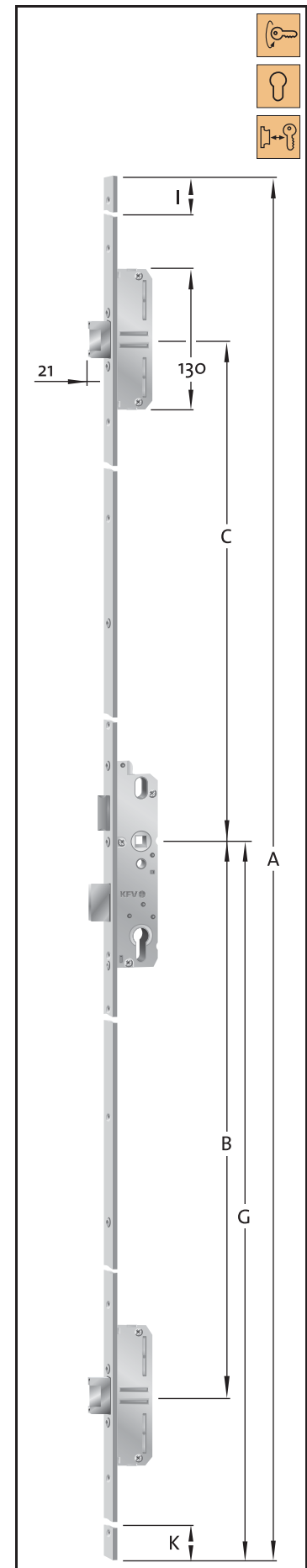





- 1
- 2
- 3
- 4
- 5
- 6
- 7
- 8
- 9

Außentüren – Rundbolzen

AS 2300

Mehrfachverriegelung mit Hauptschloss und 2 Rundbolzen
25 und 30 mm Dorn = AS 9300

Art. Nr.	Stulp	Maße
AS 2300 F 16		16 x 3 mm
AS 2300 F 20		20 x 3 mm
AS 2300 F 24		24 x 3 mm
AS 2300 P 6/24		6 x 24 x 6 x 2 mm
AS 2300 P 8/24		8 x 24 x 8 x 2 mm Niro
AS 2300 P 10/24		10 x 24 x 10 x 2 mm Niro
AS 2300 P 6/22		6 x 22 x 6 x 2 mm
AS 2300 P 8/22		8 x 22 x 8 x 2 mm Niro
AS 2300 P 10/30		10 x 30 x 10 x 2 mm

Entfernung	Dornmaß													in mm	
	92	-	-	-	35	40	45	50	55	60	65	70	80	-	100
		-	-	-	20	20	20	20	20	20	20	20	20	-	20
		8 mm, 10 mm													

Varianten in mm							
		A	B	C	G	I	K
92 mm	B001	2170	760	730	1020	290	130
	B002	2170	760	730	1050	260	160
	B003*	2400	760	980	1020	270	130
	B004*	2400	760	980	1050	240	160
	B227	2170	635	855	866	319	101
	B291	2170	635	480	1020	540	255
	B296	2170	760	355	1020	665	130
	B298	2170	760	605	1020	415	130
	B325	2170	760	355	1050	635	160
	B327	2170	760	605	1050	385	160
	K002	1754	760	730	892	-	-

* Gilt nur bei Flachstulpen

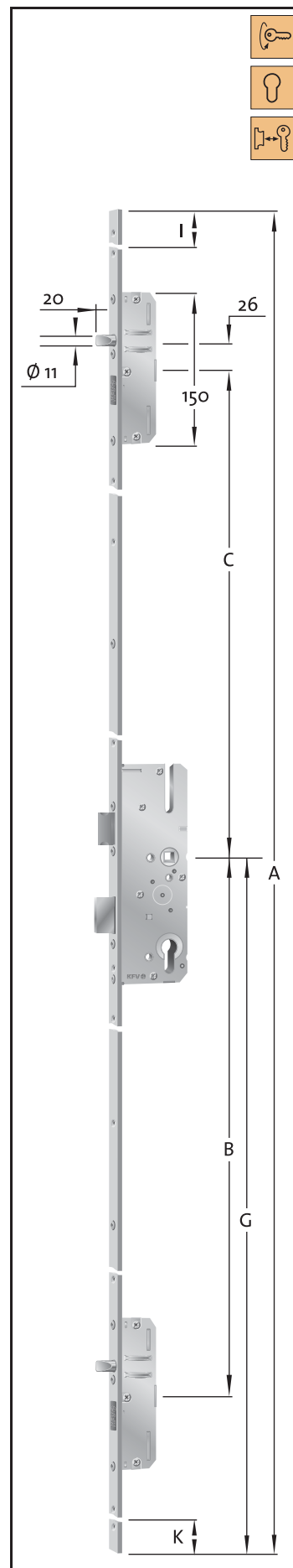

1

2

3

4

5

6



7



8

9

AS 9300

Mehrfachverriegelung mit Hauptschloss und 2 Rundbolzen

Art. Nr.	Stulp	Maße
AS 9300 F 16		16 x 3 mm
AS 9300 F 20		20 x 3 mm
AS 9300 F 24		24 x 3 mm
AS 9300 P 6/24		6 x 24 x 6 x 2 mm
AS 9300 P 8/24		8 x 24 x 8 x 2 mm Niro
AS 9300 P 10/24		10 x 24 x 10 x 2 mm Niro
AS 9300 P 6/22		6 x 22 x 6 x 2 mm
AS 9300 P 8/22		8 x 22 x 8 x 2 mm Niro
AS 9300 P 10/30		10 x 30 x 10 x 2 mm

Entfernung	Dornmaß											in mm			
 92	25	-	30	-	-	-	-	-	-	-	-	-	-	-	-
	10	-	15	-	-	-	-	-	-	-	-	-	-	-	-
	8 mm, 10 mm														

Varianten in mm							
		A	B	C	G	I	K
92 mm	B001	2170	760	730	1020	290	130
	B002	2170	760	730	1050	260	160
	B003*	2400	760	980	1020	270	130
	B004*	2400	760	980	1050	240	160
	B298	2170	760	605	1020	415	130
	B327	2170	760	605	1050	385	160

* Gilt nur bei Flachstulpen

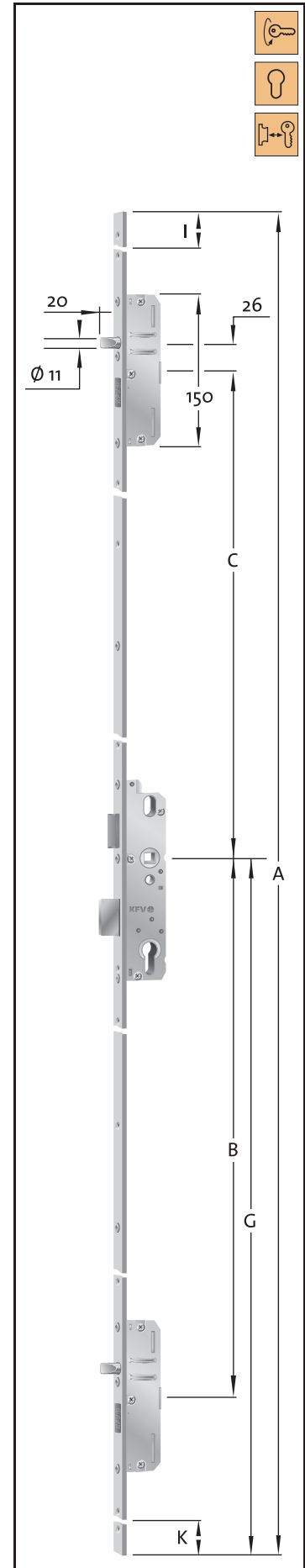





- 1
- 2
- 3
- 4
- 5
- 6
- 7
- 8
- 9

Außentüren – Rundbolzen

AS 2304

Mehrfachverriegelung mit Hauptschloss und 4 Rundbolzen
25 und 30 mm Dorn = AS 9304

Art. Nr.	Stulp	Maße
AS 2304 F 16		16 x 3 mm
AS 2304 F 20		20 x 3 mm
AS 2304 F 24		24 x 3 mm
AS 2304 P 6/24		6 x 24 x 6 x 2 mm
AS 2304 P 8/24		8 x 24 x 8 x 2 mm Niro
AS 2304 P 10/24		10 x 24 x 10 x 2 mm Niro
AS 2304 P 6/22		6 x 22 x 6 x 2 mm Niro
AS 2304 P 8/22		8 x 22 x 8 x 2 mm Niro

Entfernung	Dornmaß in mm													
 92	-	-	-	35	40	45	50	55	-	65	70	80	-	100
	-	-	-	20	20	20	20	20	-	20	20	20	-	20
	8 mm, 10 mm													

Varianten in mm									
		A	B	C	F	G	H	I	K
92 mm	B001	2170	760	730	385	1020	355	290	130
	B002	2170	760	730	385	1050	355	260	160
	B003*	2400	760	980	385	1020	480	270	130
	B004*	2400	760	980	385	1050	480	240	160
	B303	2170	885	605	510	1020	355	415	5
	B332	2170	885	605	510	1050	355	385	35

* Gilt nur bei Flachstulpen

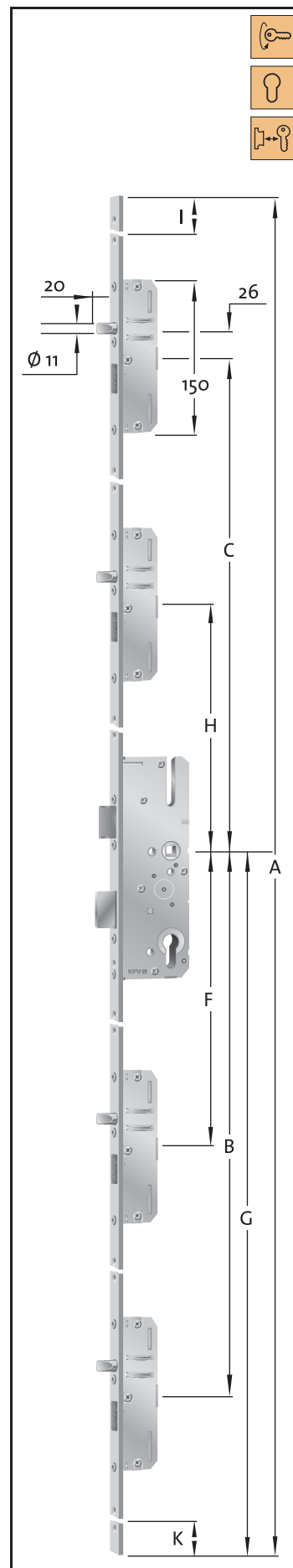

1

2

3

4

5

6



7



8

9

AS 9304

Mehrfachverriegelung mit Hauptschloss und 4 Rundbolzen

Art. Nr.	Stulp	Maße
AS 9304 F 16		16 x 3 mm
AS 9304 F 20		20 x 3 mm
AS 9304 F 24		24 x 3 mm
AS 9304 P 6/24		6 x 24 x 6 x 2 mm
AS 9304 P 8/24		8 x 24 x 8 x 2 mm Niro
AS 9304 P 10/24		10 x 24 x 10 x 2 mm Niro
AS 9304 P 6/22		6 x 22 x 6 x 2 mm
AS 9304 P 8/22		8 x 22 x 8 x 2 mm Niro

Entfernung	Dornmaß												in mm	
 92	25	-	30	-	-	-	-	-	-	-	-	-	-	
	10	-	15	-	-	-	-	-	-	-	-	-	-	
	8 mm, 10 mm													

Varianten in mm										
		A	B	C	F	G	H	I	K	
92 mm	B001	2170	760	730	385	1020	355	290	130	
	B002	2170	760	730	385	1050	355	260	160	
	B003*	2400	760	980	385	1020	480	270	130	
	B004*	2400	760	980	385	1050	480	240	160	
	B303	2170	885	605	510	1020	355	415	5	
	B332	2170	885	605	510	1050	355	385	35	

* Gilt nur bei Flachstulpen

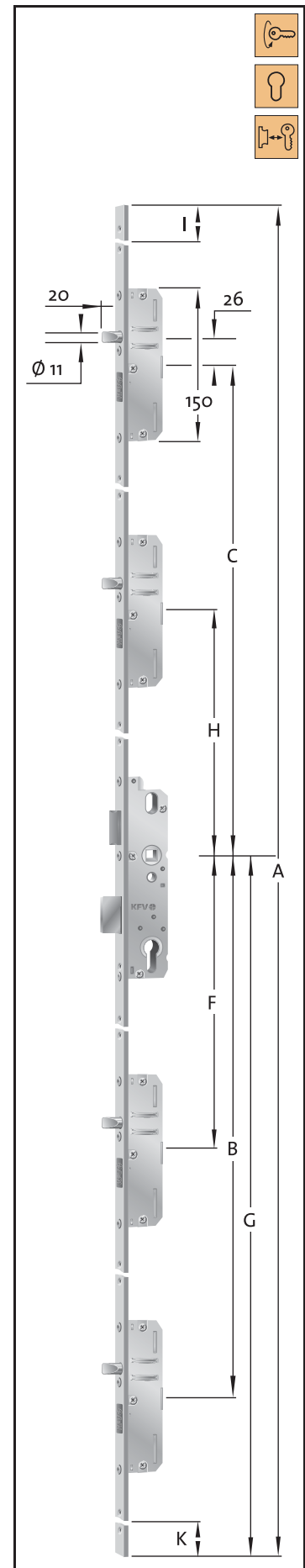

1

2

3

4

5

6

7



8



9

Außentüren – Schwenkhaken

AS 2500

Mehrfachverriegelung mit Hauptschloss und 2 Schwenkhaken
25 und 30 mm Dorn = AS 9500

Art. Nr.	Stulp	Maße
AS 2500 F 16		16 x 3 mm
AS 2500 F 20		20 x 3 mm
AS 2500 F 24		24 x 3 mm
AS 2500 P 6/24		6 x 24 x 6 x 2 mm
AS 2500 P 6/22		6 x 22 x 6 x 2 mm

Entfernung	Dornmaß in mm													
 92	-	-	-	35	40	45	50	55	-	65	70	80	-	100
	-	-	-	20	20	20	20	20	-	20	20	20	-	20
	8 mm, 10 mm													

Varianten in mm							
		A	B	C	G	I	K
92 mm	B001	2170	760	730	1020	290	130
	B002	2170	760	730	1050	260	160
	B003*	2400	760	980	1020	270	130
	B004*	2400	760	980	1050	240	160
	B298	2170	760	605	1020	415	130
	B327	2170	760	605	1050	385	160

* Gilt nur bei Flachstulpen

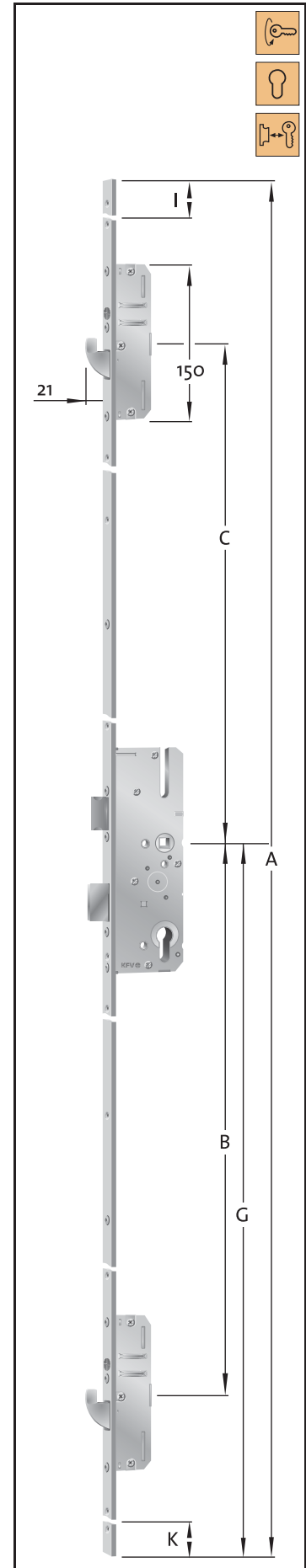

1

2

3

4

5

6



7



8

9

AS 9500

Mehrfachverriegelung mit Hauptschloss und 2 Schwenkhaken

Art. Nr.	Stulp	Maße
AS 9500 F 16		16 x 3 mm
AS 9500 F 20		20 x 3 mm
AS 9500 F 24		24 x 3 mm
AS 9500 P 6/24		6 x 24 x 6 x 2 mm
AS 9500 P 6/22		6 x 22 x 6 x 2 mm

Entfernung	Dornmaß												in mm
 92	25	-	30	-	-	-	-	-	-	-	-	-	-
	10	-	15	-	-	-	-	-	-	-	-	-	-
	8 mm, 10 mm												

Varianten in mm							
		A	B	C	G	I	K
92 mm	B001	2170	760	730	1020	290	130
	B002	2170	760	730	1050	260	160
	B003*	2400	760	980	1020	270	130
	B004*	2400	760	980	1050	240	160
	B298	2170	760	605	1020	415	130
	B327	2170	760	605	1050	385	160

* Gilt nur bei Flachstulpen

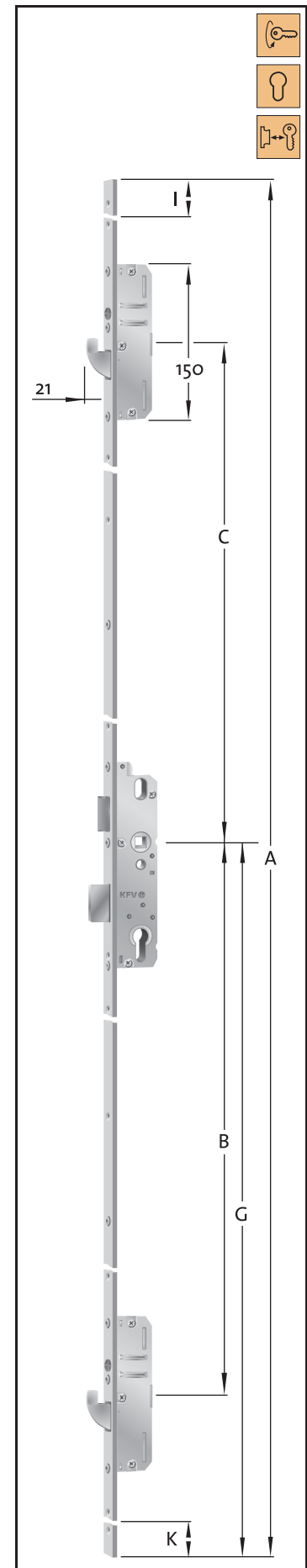

1

2

3

4

5

6

7



8



9

Außentüren – Schwenkhaken

AS 2504

Mehrfachverriegelung mit Hauptschloss und 4 Schwenkhaken
25 und 30 mm Dorn = AS 9504

Art. Nr.	Stulp	Maße
AS 2504 F 16		16 x 3 mm
AS 2504 F 20		20 x 3 mm
AS 2504 P 6/24		6 x 24 x 6 x 2 mm

Entfernung	Dornmaß												in mm			
 92	-	-	-	35	40	45	-	-	-	-	-	-	-	-	-	-
	-	-	-	20	20	20	-	-	-	-	-	-	-	-	-	-
	8 mm, 10 mm															

Varianten in mm										
		A	B	C	F	G	H	I	K	
92 mm	B001	2170	760	730	385	1020	355	290	130	
	B003*	2400	760	980	385	1020	480	270	130	
	B303	2170	885	605	510	1020	355	415	5	

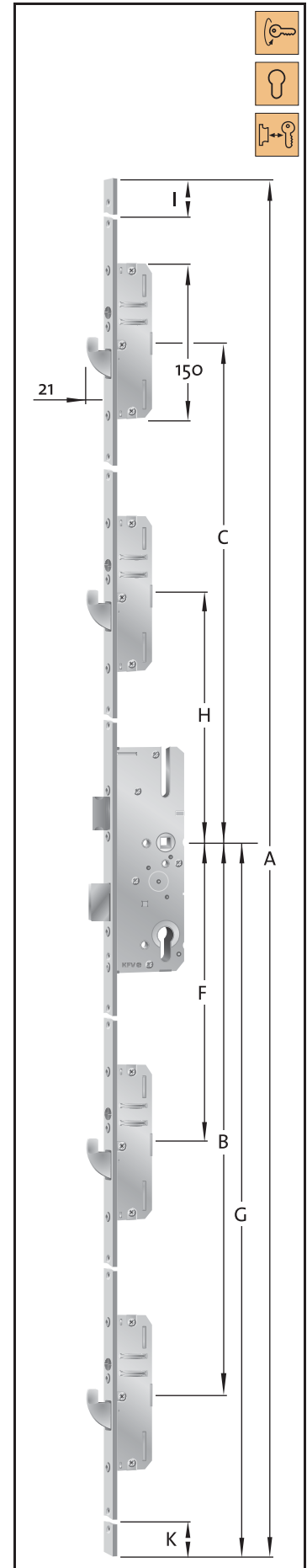

* Gilt nur bei Flachstulpen







1
2
3
4
5
6
7
8
9

AS 9504

Mehrfachverriegelung mit Hauptschloss und 4 Schwenkhaken

Art. Nr.	Stulp	Maße
AS 9504 F 16		16 x 3 mm
AS 9504 F 20		20 x 3 mm
AS 9504 P 6/24		6 x 24 x 6 x 2 mm

Entfernung	Dornmaß in mm												
 92	25	-	30	-	-	-	-	-	-	-	-	-	-
	10	-	15	-	-	-	-	-	-	-	-	-	-
	8 mm, 10 mm												

Varianten in mm										
		A	B	C	F	G	H	I	K	
92 mm	B001	2170	760	730	385	1020	355	290	130	
	B003*	2400	760	980	385	1020	480	270	130	
	B303	2170	885	605	510	1020	355	415	5	

* Gilt nur bei Flachstulpen

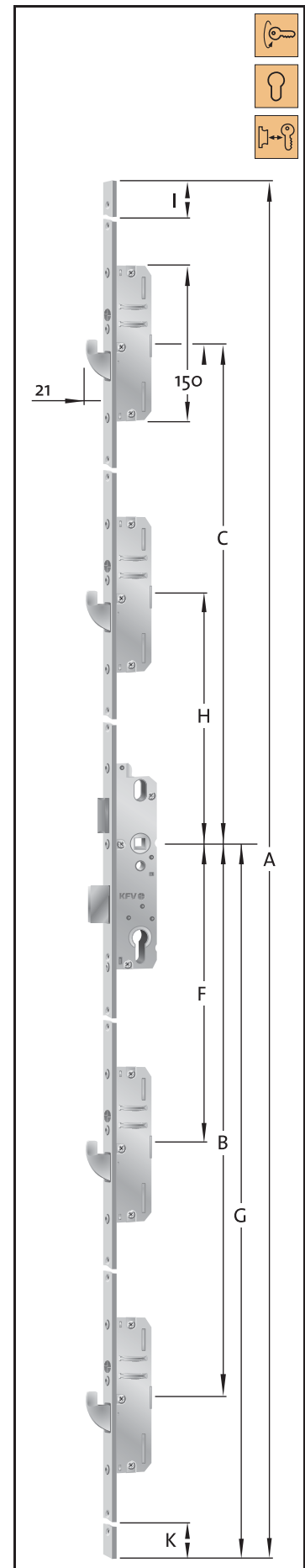





- 1
- 2
- 3
- 4
- 5
- 6
- 7
- 8
- 9

Außentüren – Bolzen-Schwenkhaken-Kombination

AS 2600

Mehrfachverriegelung mit Hauptschloss und 2x Bolzen-Schwenkhaken-Kombination
25 und 30 mm Dorn = AS 9600

Art. Nr.	Stulp	Maße
AS 2600 F 16		16 x 3 mm
AS 2600 F 20		20 x 3 mm
AS 2600 F 24		24 x 3 mm
AS 2600 P 6/24		6 x 24 x 6 x 2 mm
AS 2600 P 8/24		8 x 24 x 8 x 2 mm Niro
AS 2600 P 10/24		10 x 24 x 10 x 2 mm Niro
AS 2600 P 6/22		6 x 22 x 6 x 2 mm
AS 2600 P 8/22		8 x 22 x 8 x 2 mm Niro
AS 2600 P 10/30		10 x 30 x 10 x 2 mm

Entfernung	Dornmaß													in mm	
	92	-	-	-	35	40	45	50	55	-	65	70	80	-	100
		-	-	-	20	20	20	20	20	-	20	20	20	-	20
		8 mm, 10 mm													

Varianten in mm							
		A	B	C	G	I	K
92 mm	B001	2170	760	730	1020	290	130
	B002	2170	760	730	1050	260	160
	B003*	2400	760	980	1020	270	130
	B004*	2400	760	980	1050	240	160
	B291	2170	635	480	1020	540	255
	B296	2170	760	355	1020	665	130
	B298	2170	760	605	1020	415	130
	B325	2170	760	355	1050	635	160
	B327	2170	760	605	1050	385	160
	K002	1754	760	730	892	-	-

* Gilt nur bei Flachstulpen

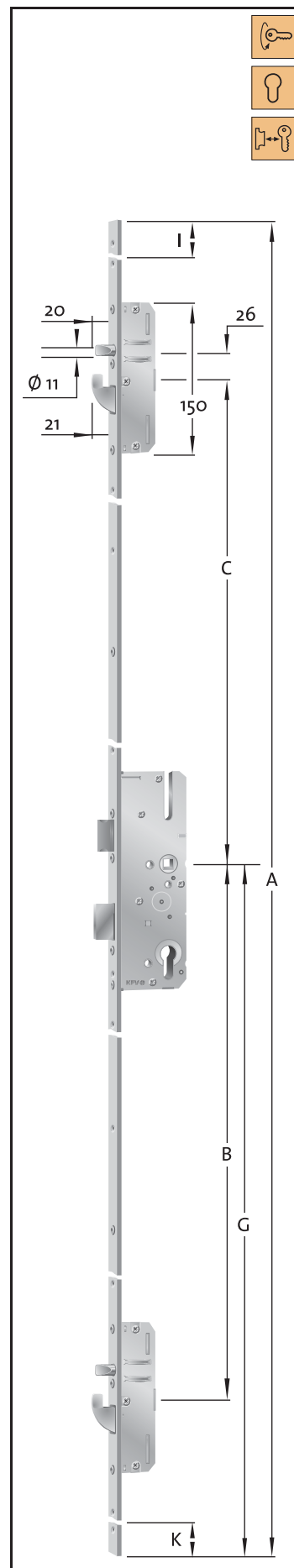

1

2

3

4

5

6



7



8

9

AS 9600

Mehrfachverriegelung mit Hauptschloss und 2x Bolzen-Schwenkhaken-Kombination

Art. Nr.	Stulp	Maße
AS 9600 F 16		16 x 3 mm
AS 9600 F 20		20 x 3 mm
AS 9600 F 24		24 x 3 mm
AS 9600 P 6/24		6 x 24 x 6 x 2 mm
AS 9600 P 8/24		8 x 24 x 8 x 2 mm Niro
AS 9600 P 10/24		10 x 24 x 10 x 2 mm Niro
AS 9600 P 6/22		6 x 22 x 6 x 2 mm
AS 9600 P 8/22		8 x 22 x 8 x 2 mm Niro
AS 9600 P 10/30		10 x 30 x 10 x 2 mm

Entfernung	Dornmaß											in mm				
 92	25	-	30	-	-	-	-	-	-	-	-	-	-	-	-	-
	10	-	15	-	-	-	-	-	-	-	-	-	-	-	-	-
	8 mm, 10 mm															

Varianten in mm							
		A	B	C	G	I	K
92 mm	B001	2170	760	730	1020	290	130
	B002	2170	760	730	1050	260	160
	B003*	2400	760	980	1020	270	130
	B004*	2400	760	980	1050	240	160
	B298	2170	760	605	1020	415	130
	B327	2170	760	605	1050	385	160

* Gilt nur bei Flachstulpen

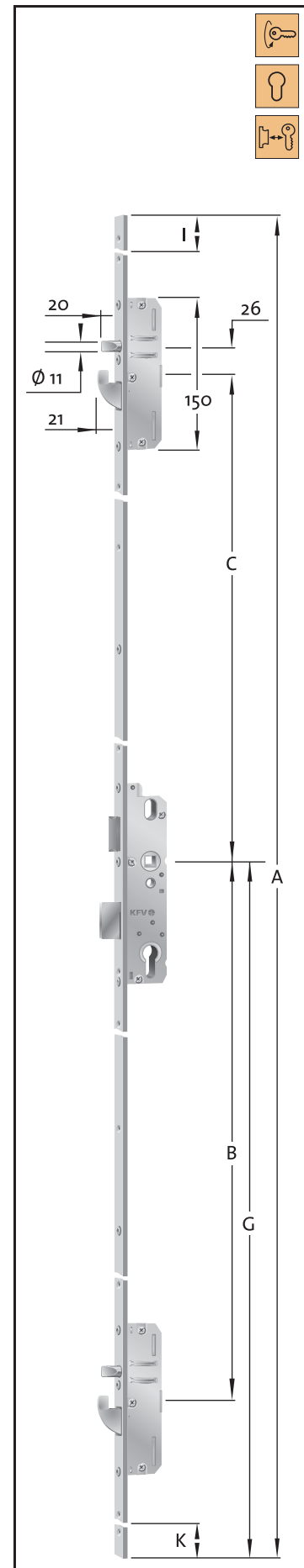

1

2

3

4

5

6



7



8

9

AS 2608

Mehrfachverriegelung mit Hauptschloss und 4x Bolzen-Schwenkhaken-Kombination

Art. Nr.	Stulp	Maße
AS 2608 F 16		16 x 3 mm
AS 2608 F 20		20 x 3 mm
AS 2608 P 6/24		6 x 24 x 6 x 2 mm

Entfernung	Dornmaß in mm													
 92	-	-	-	35	40	45	-	55	-	65	-	80	-	-
	-	-	-	20	20	20	-	20	-	20	-	20	-	-
	8 mm, 10 mm													

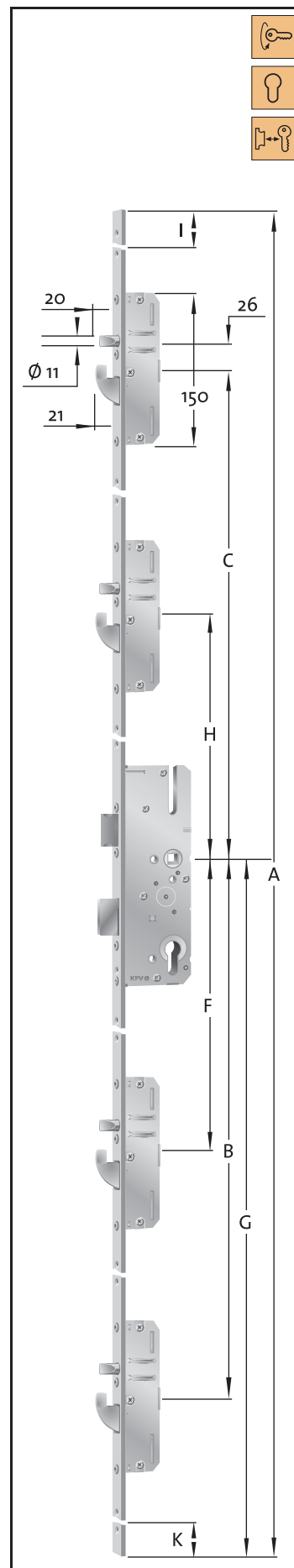

Varianten in mm									
		A	B	C	F	G	H	I	K
92 mm	B001	2170	760	730	385	1020	355	290	130
	B002	2170	760	730	385	1050	355	260	160







1
2
3
4
5
6
7
8
9

AS 2750

Mehrfachverriegelung mit Hauptschloss und 3 Fallen und zusätzlicher Stahl-Schwenkhaken-Arretierung

Art. Nr.	Stulp	Maße
AS 2750 F 16		16 x 3 mm
AS 2750 F 20		20 x 3 mm
AS 2750 F 24		24 x 3 mm
AS 2750 P 6/24		6 x 24 x 6 x 2 mm
AS 2750 P 10/30		10 x 30 x 10 x 2 mm

Entfernung	Dornmaß													in mm	
 92	-	-	-	35	40	45	-	55	-	65	-	-	-	-	-
	-	-	-	20	20	20	-	20	-	20	-	-	-	-	-
	8 mm, 10 mm														

Varianten in mm							
		A	B	C	G	I	K
92 mm	B001	2170	760	730	1020	290	130
	B002	2170	760	730	1050	260	160
	B003*	2400	760	980	1020	270	130
	B004*	2400	760	980	1050	240	160
	B298	2170	760	605	1020	415	130
	B327	2170	760	605	1050	385	160

* Gilt nur bei Flachstulpen

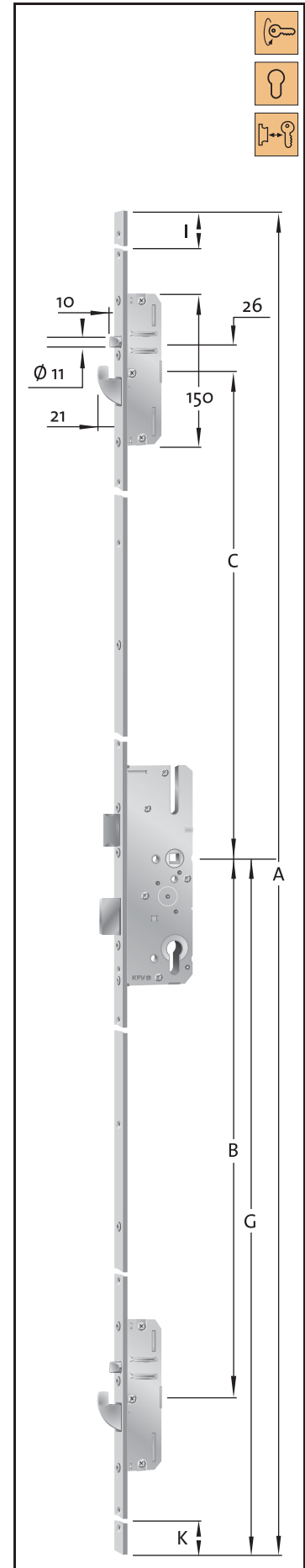





- 1
- 2
- 3
- 4
- 5
- 6
- 7
- 8
- 9

Außentüren – Schließzapfen

AS 8250

Mehrfachverriegelung mit Hauptschloss und 4 verstellbaren Schließzapfen
25 und 30 mm Dorn = AS 9800

Art. Nr.	Stulp	Maße
AS 8250 F 16		16 x 3 mm
AS 8250 F 20		20 x 3 mm
AS 8250 P 6/24		6 x 24 x 6 x 2 mm

Entfernung	Dornmaß in mm												
 92	-	-	-	35	40	45	50	-	-	-	-	-	-
	-	-	-	20	20	20	20	-	-	-	-	-	-
	8 mm, 10 mm												

Varianten in mm										
		A	B	C	F	G	H	I	K	
92 mm	Stand.	2170	823	810	410	1020	260	260	137	

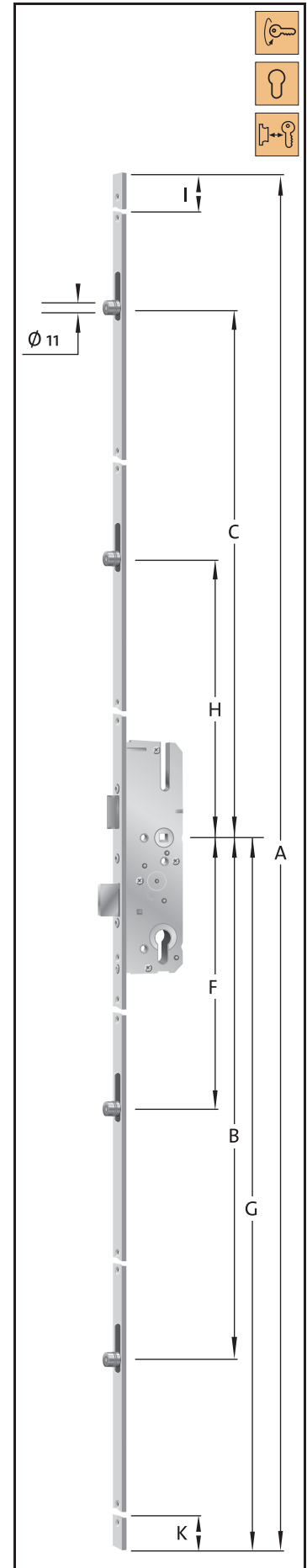

1

2

3

4

5

6



7



8

9

AS 9800

Mehrfachverriegelung mit Hauptschloss und 4 verstellbaren Schließzapfen

Art. Nr.	Stulp	Maße
AS 9800 F 16		16 x 3 mm
AS 9800 F 20		20 x 3 mm
AS 9800 P 6/24		6 x 24 x 6 x 2 mm

Entfernung	Dornmaß in mm												
 92	25	-	30	-	-	-	-	-	-	-	-	-	-
	10	-	15	-	-	-	-	-	-	-	-	-	-
	8 mm, 10 mm												

Varianten in mm										
		A	B	C	F	G	H	I	K	
92 mm	Stand.	2170	823	810	410	1020	260	260	137	

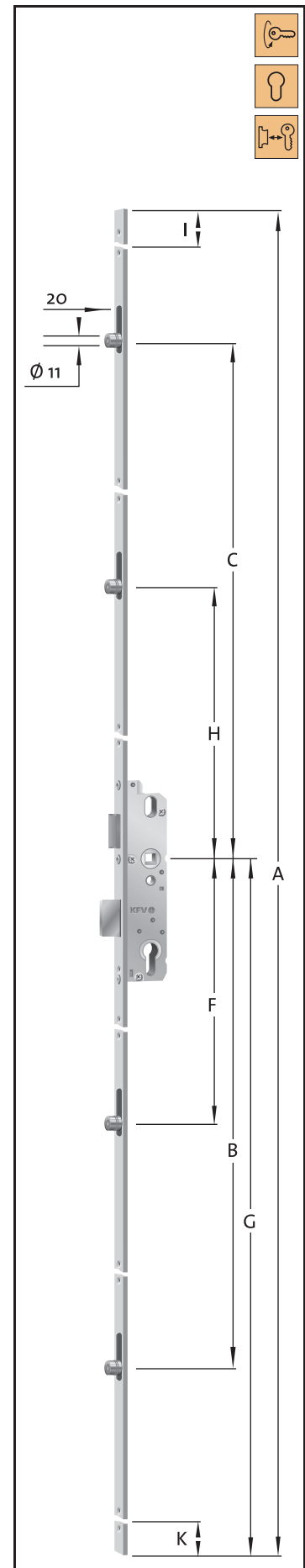

1

2

3

4

5

6

7

8



9

Außentüren – Schließzapfen

AS 8092

Mehrfachverriegelung mit Hauptschloss und 4 verstellbaren Schließzapfen

Art. Nr.	Stulp	Maße
AS 8092 F 16		16 x 3 mm
AS 8092 F 20		20 x 3 mm

Entfernung	Dornmaß													in mm			
 92	-	-	-	-	-	-	-	-	55	-	65	-	80	-	-		
	-	-	-	-	-	-	-	-	20	-	20	-	20	-	-		
	10 mm																

Varianten in mm									
		A	B	C	F	G	H	I	K
92 mm	K	2030	970	730	410	1049	260	170	-
	R 2	2170	770	730	410	1049	260	310	219
	Stand.	2170	970	910	410	1049	260	130	-

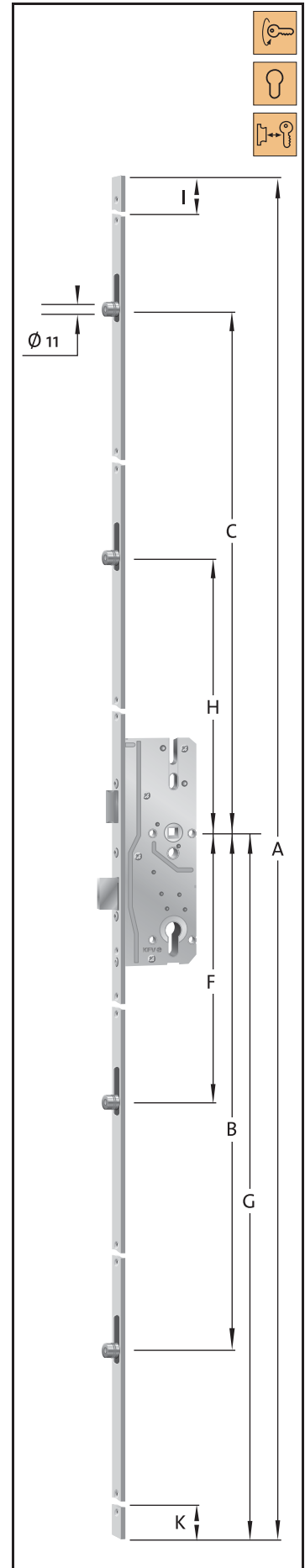

1

2

3

4

5

6

7



8

9

AS 2321

Mehrfachverriegelung mit Hauptschloss und 2 Rundbolzen und 2 verstellbaren Schließzapfen

Art. Nr.	Stulp	Maße
AS 2321 F 16		16 x 3 mm
AS 2321 F 20		20 x 3 mm

Entfernung	Dornmaß in mm													
 92	-	-	-	-	-	45	-	55	-	65	70	80	-	-
	-	-	-	-	-	20	-	20	-	20	20	20	-	-
	10 mm													

Varianten in mm										
		A	B	C	F	G	H	I	K	
92 mm	W 3	2170	884	726	403	1050	268	310	110	

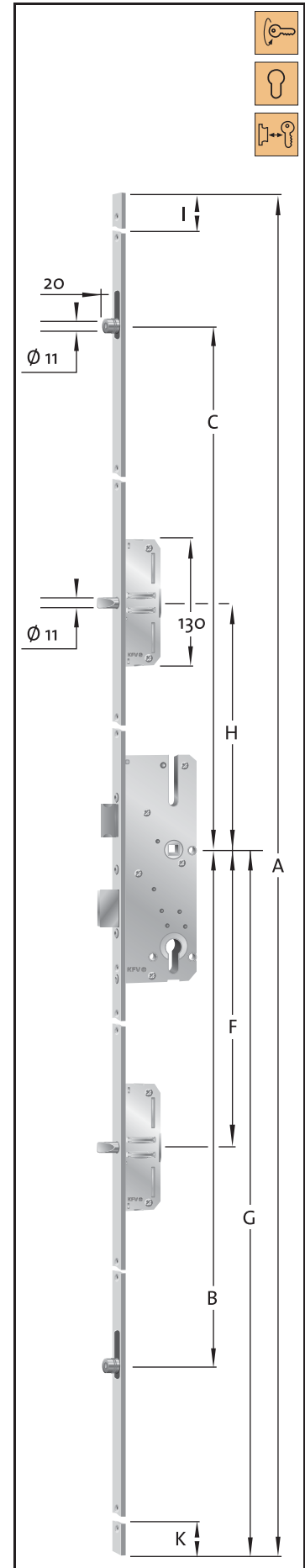





- 1
- 2
- 3
- 4
- 5
- 6
- 7
- 8
- 9

Außentüren – Pilzzapfen

AS 8100

Mehrfachverriegelung mit Hauptschloss und 4 verstellbaren Pilzzapfen
25 und 30 mm Dorn = AS 9810

Art. Nr.	Stulp	Maße
AS 8100 F 16		16 x 3 mm
AS 8100 F 20		20 x 3 mm

Entfernung	Dornmaß in mm													
 92	-	-	-	35	40	45	-	-	-	-	-	-	-	-
	-	-	-	20	20	20	-	-	-	-	-	-	-	-
	8 mm													

Varianten in mm										
		A	B	C	F	G	H	I	K	
92 mm	Stand.	2170	823	810	410	1020	260	260	137	

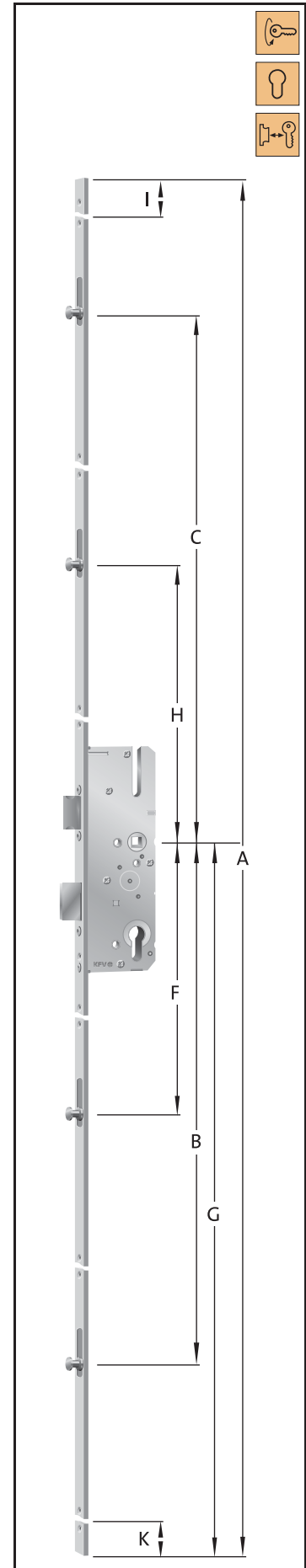





1
2
3
4
5
6
7
8
9

AS 9810

Mehrfachverriegelung mit Hauptschloss und 4 verstellbaren Pilzzapfen

Art. Nr.	Stulp	Maße
AS 9810 F 16		16 x 3 mm
AS 9810 F 20		20 x 3 mm

Entfernung	Dornmaß in mm													
 92	25	-	30	-	-	-	-	-	-	-	-	-	-	-
	10	-	15	-	-	-	-	-	-	-	-	-	-	-
	8 mm													

Varianten in mm									
		A	B	C	F	G	H	I	K
92 mm	Stand.	2170	823	810	410	1020	260	260	137

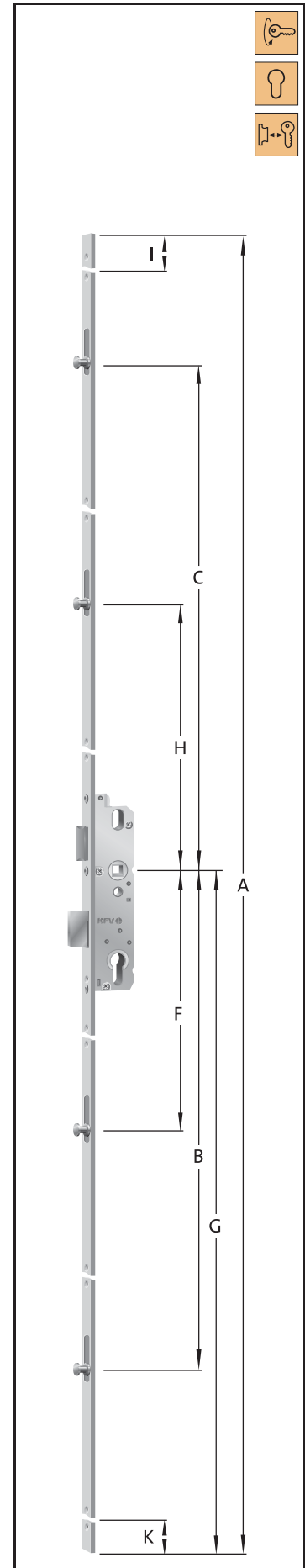





- 1
- 2
- 3
- 4
- 5
- 6
- 7
- 8
- 9

AS 2372

Mehrfachverriegelung mit Hauptschloss und 2 Rundbolzen

Art. Nr.	Stulp	Maße
AS 2372 F 16		16 x 3 mm
AS 2372 F 20		20 x 3 mm

Entfernung	Dornmaß in mm														
 72	-	-	-	-	-	-	-	-	55	-	65	70	80	-	-
	-	-	-	-	-	-	-	20	-	20	20	20	-	-	
	8 mm														

Varianten in mm							
		A	B	C	G	I	K
72 mm	B001	2170	760	730	1020	290	130
	B002	2170	760	730	1050	260	160
	B166	1855	760	730	952	43	62
	B325	2170	760	355	1050	635	160
	B327	2170	760	605	1050	385	160
	K015	2170	697,5	730	1050	260	222,5
	K007	1847	822,5	730	970	-	-

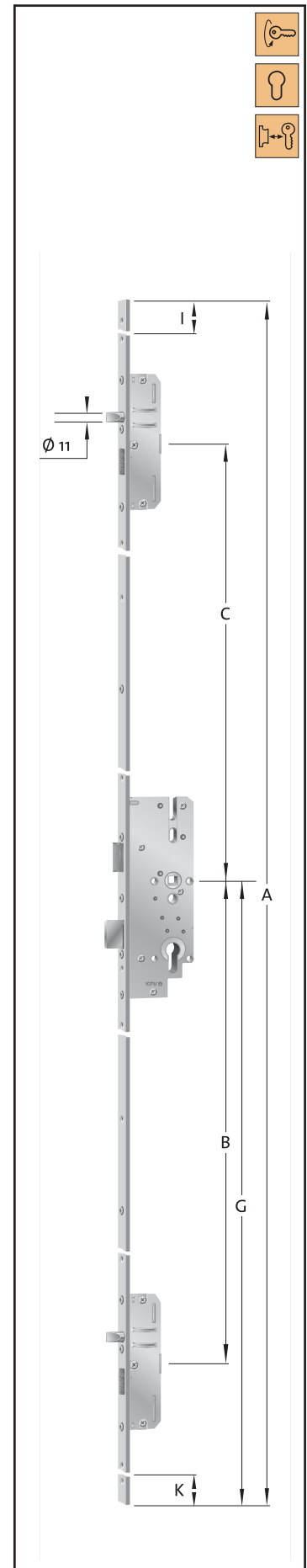





1
2
3
4
5
6
7
8
9

AS 2602

Mehrfachverriegelung mit Hauptschloss und 2x Bolzen-Schwenkhaken-Kombination

Art. Nr.	Stulp	Maße
AS 2602 F 16		16 x 3 mm
AS 2602 F 20		20 x 3 mm

Entfernung	Dornmaß in mm														
 72	-	-	-	-	-	-	-	-	55	-	65	70	80	-	-
	-	-	-	-	-	-	-	-	20	-	20	20	20	-	-
	8 mm														

Varianten in mm							
		A	B	C	G	I	K
72 mm	B001	2170	760	730	1020	290	130
	B002	2170	760	730	1050	260	160
	B166	1855	760	730	952	43	62
	K007	1847	822,5	730	970	-	-

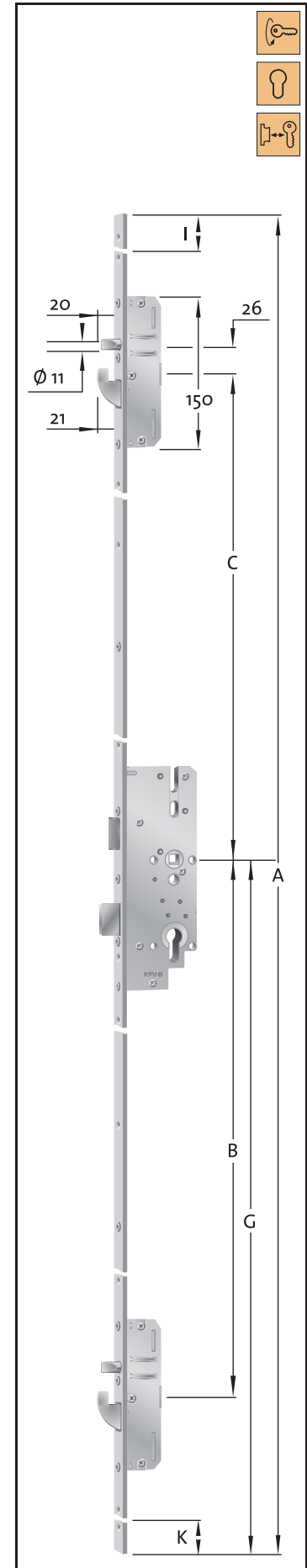

- 1
- 2
- 3
- 4
- 5
- 6
- 7
- 8
- 9

AS 8772

Mehrfachverriegelung mit Hauptschloss und 4 verstellbaren Schließzapfen

Art. Nr.	Stulp	Maße
AS 8772 F 16		16 x 3 mm
AS 8772 F 20		20 x 3 mm

Entfernung	Dornmaß													in mm			
72	-	-	-	-	-	-	-	-	55	-	65	-	-	-	-	-	-
	-	-	-	-	-	-	-	20	-	20	-	-	-	-	-	-	-
	8 mm																

Varianten in mm										
		A	B	C	F	G	H	I	K	
72 mm	Stand.	2170	970	910	410	1042	260	138		

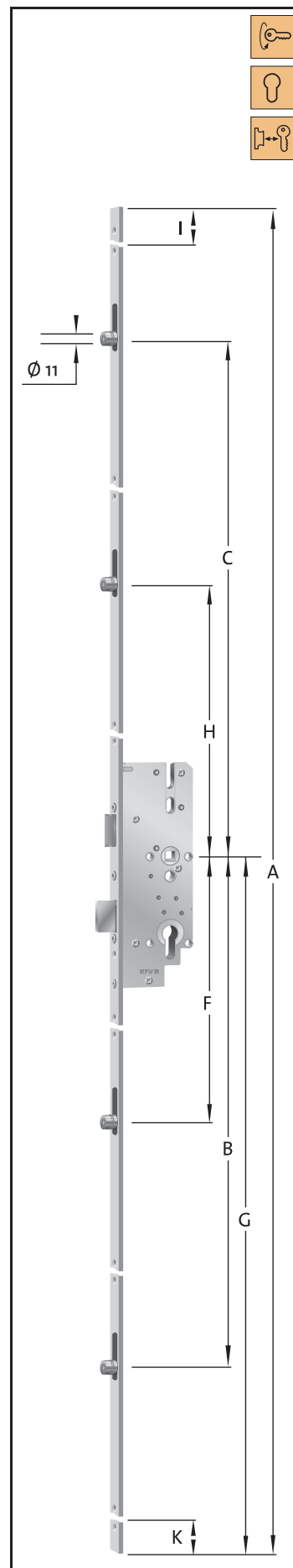

1
2
3
4
5
6
7
8
9



1

2

3

4

5

6

7

8

9

Stulpflügelbeschlag



1
2
3
4
5
6
7
8
9

Serie 230, 280, 504-1, 733-2

Ausführung für Holz und PVC

- Zweiteiliger Stulpflügelbeschlag mit 20 mm nach oben und unten ausschließenden Riegeln. Vorgelesen für den Einsatz am Standflügel von zweiflügeligen Türen.
- Einfach über den Hebel – der unterhalb der Standarddrückerhöhe installiert ist – zu verriegeln und entriegeln.
- Standardausführung hellverzinkt oder RAL 9007 beschichtet.

Ihre Vorteile:

- für zweiflügelige Außen- und Durchgangstüren
- besonders sicher durch starke Bolzen
- mit Komfortgriff in der Mitte
- für den Standflügel in Kombination mit allen mechanischen und elektronischen KFV-Mehrfachverriegelungen im Rastermaß
- rechts oder links (bitte Gehflügel-Richtung angeben)

Serie 230

Profilabmessung: 14 x 30 x 8 mm
 Achsmaß: 15 mm
 AT-Stück 115-41
 mit Rutsche im Öffnerbereich
 mit verstellbarem Gusskasten
 Riegelmaß 11,5 x 4 mm

Serie 504-1

Profilabmessung: 14 x 24 x 8 mm
 Achsmaß: 9 mm
 mit fest montiertem AT-Stück
 (kein E-Öffner Einsatz möglich)
 ohne verstellbaren Gusskasten
 Riegelmaß 11,5 x 4 mm

Serie 280

Profilabmessung: 14 x 28 x 8 mm
 Achsmaß: 13 mm
 AT-Stück 115-41
 nur mit abgesetzter Falle einsetzbar
 mit Rutsche im Öffnerbereich
 mit verstellbarem Gusskasten
 Riegelmaß 11,5 x 4 mm

Serie 733-2

Profilabmessung: 8 x 28 x 8 mm
 Achsmaß: 13 mm
 AT-Stück 115-41
 nur mit abgesetzter Falle einsetzbar
 mit Rutsche im Öffnerbereich
 mit verstellbarem Gusskasten
 mit Öffnungssperre
 Riegelmaß 11,5 x 4 mm

Sonderausführungen

- ⇒ mit AT-Stück Nr. 115-41, austauschbar gegen elektrischen Türöffner eff-eff, Modell Nr. 119 E-130 (DIN links) und Modell Nr. 119 E 131 (DIN rechts)

Bestellhinweise:

Bitte die jeweilige Seriennummer hinter die Artikelnummer setzen.

Beispiel: Grundteil + Endstück **BS60-230G B298 + V7710-230**

Standflügelseite

Maßvariante		L Länge	Max. kürzbar auf	B	C	G	I	H
B 001	für	2070	1940	760	730	1020	130	735
B 002	Standardtüren	2070	1970	760	730	1050	100	765
B 298	für	1950	1816	760	605	1020	134	735
B 327	niedrige Türen	1950	1846	760	605	1050	104	765
B 602	für	2200	2066	760	855	1020	134	735
B 638	hohe Türen	2200	2096	760	855	1050	104	765

Alle Angaben in mm.

Bestellbeispiele:

Stulpflügelbeschlag für Holztüren mit Achslage 13 mm

1.) Grundbeschlag

Artikelbezeichnung	Länge (max. Kürzbarkeit)
BS60-280-EG, AT 115-41-B002	2070 mm (-130 mm)
BS60-280-EG, AT 115-41-B327	1950 mm (-134 mm)

2.) Endstück

Artikelbezeichnung	Länge
V7710-280	100 mm
V7720-280	200 mm
V7730-280	300 mm
V7740-280	400 mm

3.) Verlängerung

Artikelbezeichnung	Länge
V7033-230	200 mm

4.) Zusammenbaubeispiele



Grundbauteil & Endstück	Flügelalzhöhe
Grundbauteil BS60-280-EG-B327 mit Endstück V7710-280	1916 bis 2050 mm
Grundbauteil BS60-280-EG-B327 mit Endstück V7710-280	2016 bis 2150 mm
Grundbauteil BS60-280-EG-B002 mit Endstück V7710-280	2040 bis 2170 mm
Grundbauteil BS60-280-EG-B002 mit Endstück V7720-280	2140 bis 2270 mm
BS60-280-EG-B002 mit V7710-280 und Verlängerung V7033-280	2240 bis 2370 mm
BS60-280-EG-B002 mit V7720-280 und Verlängerung V7033-280	2340 bis 2470 mm

- Richtungsangabe nach Gangflügel / Anschraublöcher auf Achslage 13 mm
- Eff Eff- E- Öffner DIN Rechts: 119-E 131 / Eff Eff- E- Öffner DIN Links: 119-E 130
- Maße des Riegels: 11,5 x 4 mm / Mitte vertikale Riegel auf Achslage 13 mm





Stulpflügelbeschlag

Standflügel

Endstücke mit Durchbrüchen für Verriegelung

Endstück	Länge	Maßvariante
 V7736 -230G -733-2G	300 mm	B001 B002
 V7746 -230G -733-2G	400 mm	B001 B002

Endstücke ohne Durchbrüche

Endstück Länge 400 mm	Endstück Länge 300 mm
 V7740 -230 -280 -504-1 -733-2	 V7730 -230 -280 -504-1 -733-2
 V7720 -230 -280 -504-1 -733-2	 V7710 -230 -280 -504-1 -733-2

Zwischenstück Länge 200 mm
 V7033 -230 -280 -504-1 -733-2

Grundteil

Grundteil		
BS60 -230G -280G -504-1A -733-2G	B 001 B 002	für Standardtüren
	B 298 B 327	für niedrige Türen
	B 602 B 638	für hohe Türen

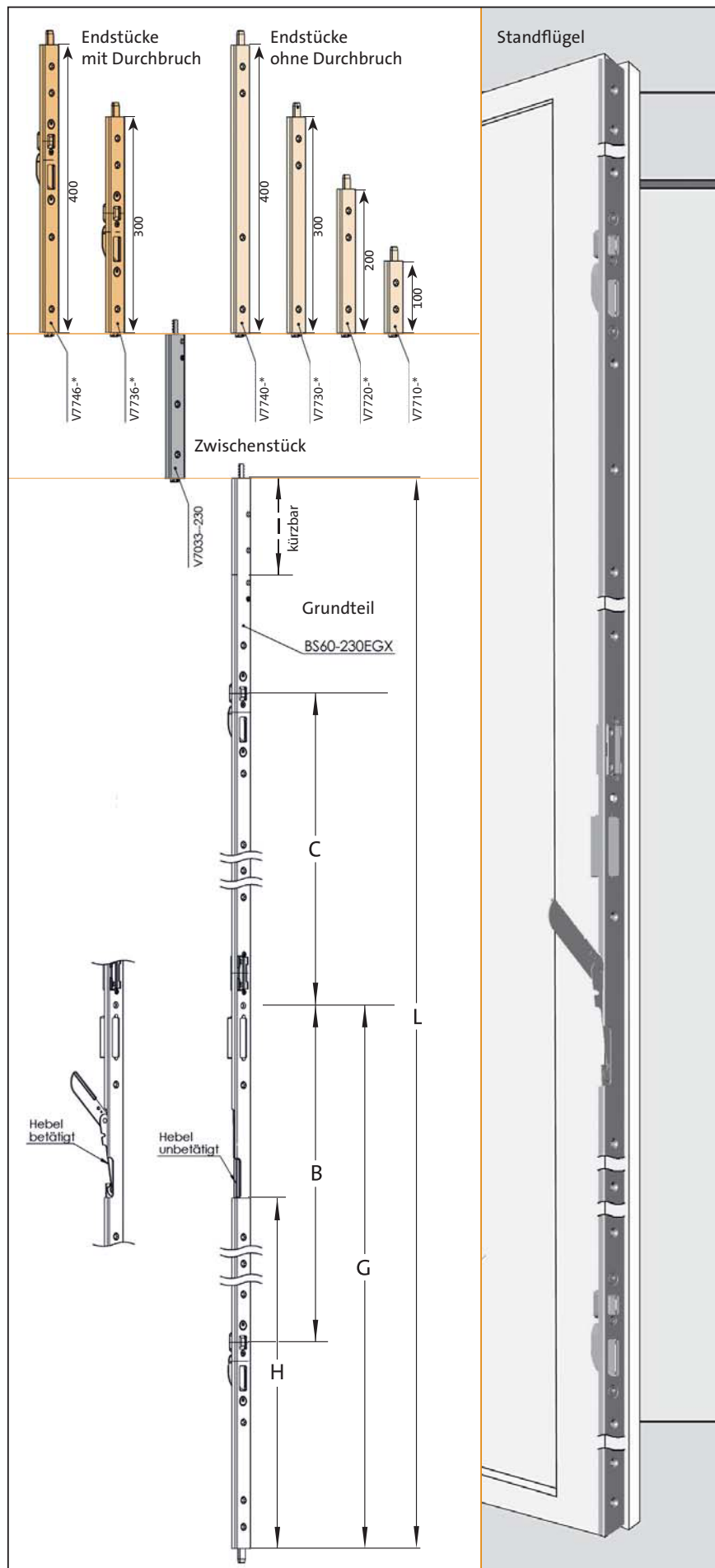

Kürzbarkeiten in Verbindung mit der Mehrfachverriegelung beachten.

1
2
3
4
5
6
7
8
9

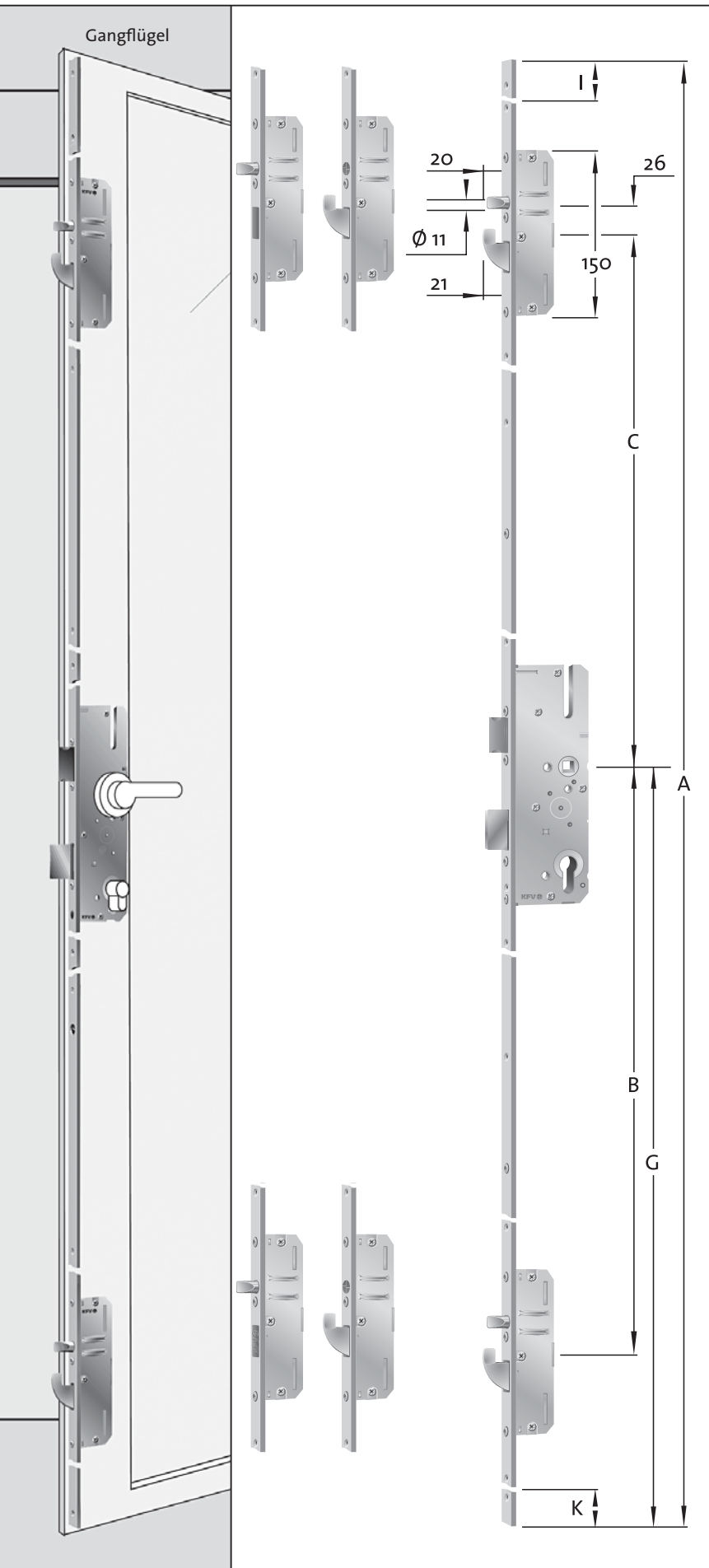

Gangflügel

Endstücke mit Verriegelung

Endstück	Länge	I	G	für Mehrfachverriegelung
V2300-1 V2500-1 V2600-1	500	220	180	V001 V002
V2300 V2500 V2600	500	126	274	V001 V002

Alle Angaben in mm.

Verlängerung (optional)

Blindstück Länge 400 mm	
8035-45	Optional Einsatz eines Blindstückes bei weiterer Verlängerung, kürzbar

Mehrfachverriegelung

Mehrfachverriegelung		
AS 2300 AS 2500 AS 2600	B 001 B 002	für Standardtüren
	B 298 B 327	für niedrige Türen
	B 602 B 638	für hohe Türen
	V 001 V 002	für den Einsatz von Endstücken mit Verriegelung

Ausführungen

Maßvariante	A	B	C	G	I	K
B 001	2170	760	730	1020	290	130
B 002	2170	760	730	1050	260	160
B 298	2170	760	605	1020	430	62
B 327	2170	760	605	1050	415	160
B 602	2400	760	855	1020	395	130
B 638	2400	760	855	1050	365	160
V 001	2100	760	730	1020	220	130
V 002	2100	760	730	1050	190	160

Alle Angaben in mm.



Stulpflügelbeschlag

Einbaurichtlinien

Abb. 1 Einbau des Stulpflügelbeschlages zur Mehrfachverriegelung

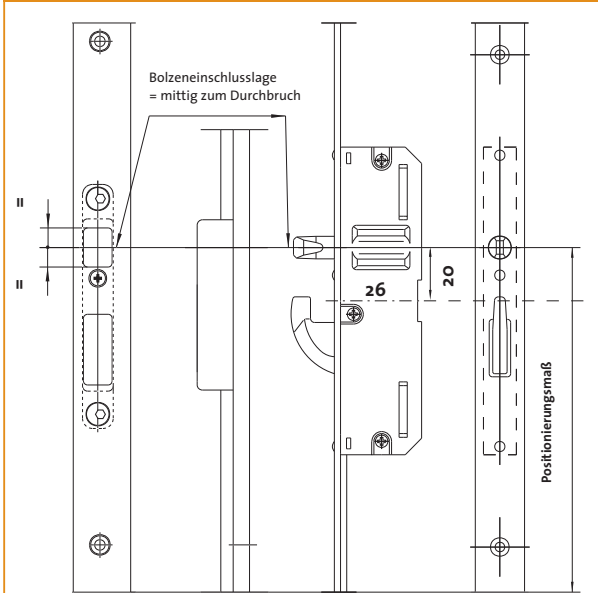

Stulpflügelbeschlags- und Verschlussausführung nach Auftrag

Abb. 2 Positionierung (Einbaulage des Stulpflügelbeschlages zum Schließblech

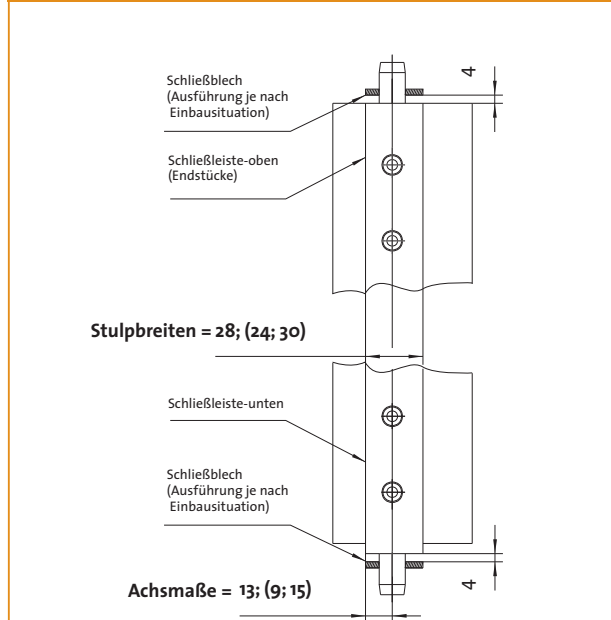

Allgemeine Hinweise

Hebel unbetätigt
(geschlossene Stellung)

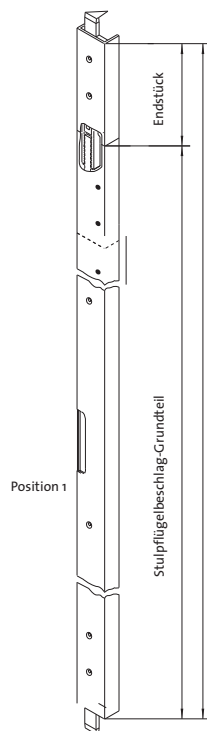

Hebel betätigt
(offene Stellung)

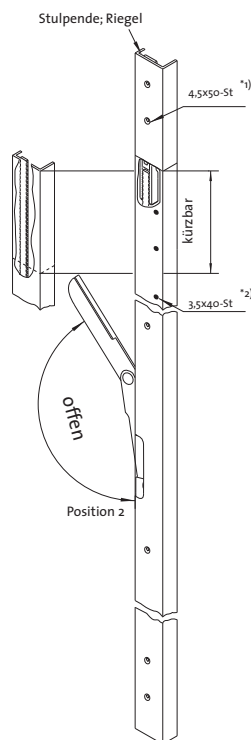

wie gezeichnet DIN rechts
spiegelbildlich DIN links

Hebelbetätigung/Kürzbarkeit des Stulpflügelbeschlages:

- Pos. 1: Hebel bei geschlossener Stellung bündig abschließend zur Stulpbreite. Beide Riegel sind komplett ausgefahren.
- Pos. 2: In Offenstellung sind beide Riegel bündig zu den Stulpenden. Der Stulpflügelbeschlag kann nun, falls erforderlich, am Grundteil gekürzt werden. (Für den Stulp und die Treibstangenverzahnung muss danach wieder die Gratfreiheit gewährleistet sein.) Das Maß der Kürzbarkeit richtet sich nach der B-Ausführung und der Flügelfalzhöhe.

Anschraublöcher des Stulpflügelbeschlages:

- Alle Anschraublöcher sind bei der Montage vorzubohren. Die Verschraubungslöcher dürfen nicht aufgebohrt und die Distanzhülsen dürfen nicht entfernt werden.
- empfohlene Schrauben:
 - *1) Senk-Holzschraube Din 97-/ 7997-4,5 x 50-St
 - *2) Senk-Holzschraube Din 97-/ 7997-3,5 x 40-St

Richtungsangabe des Stulpflügelbeschlages:

- entsprechend unseren Schließleisten, DIN links, DIN rechts; richtungsweisend ist der Gehflügel.

1
2
3
4
5
6
7
8
9

Abb. 3 Einbausituation Serie 504-1 (A) für Eurofalz



Abb. 6 Einbausituation Serie 230 (EG) für 4 mm Falzluf



Abb. 4 Einbausituation Serie 280 (EG) für 4 mm Falzluf

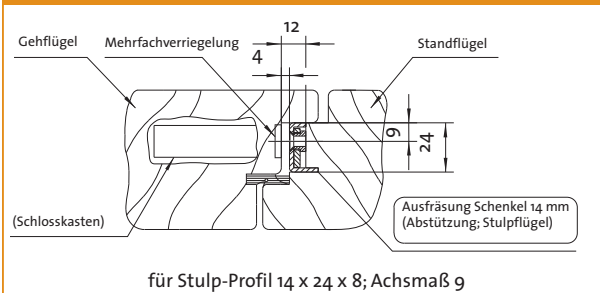

Abb. 7 Einbausituation Serie 733-2 (EG) für den Kunststoffbereich

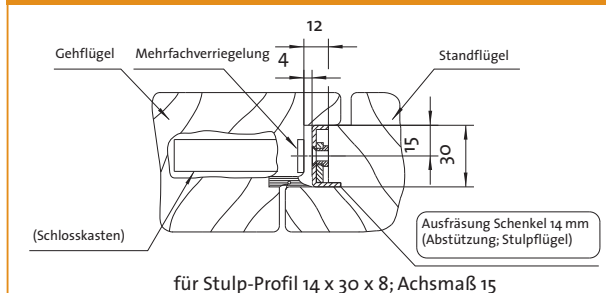

Abb. 5 Einbausituation Serie 504-1 (A) für Euronut

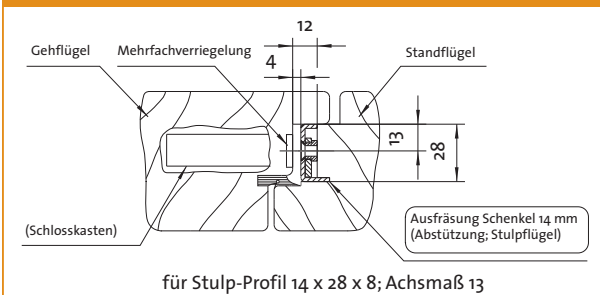

Allgemeine Hinweise

Beim Einsatz einer Mehrfachverriegelung in Verbindung mit dem Stulpflügelbeschlag ist darauf zu achten, dass:

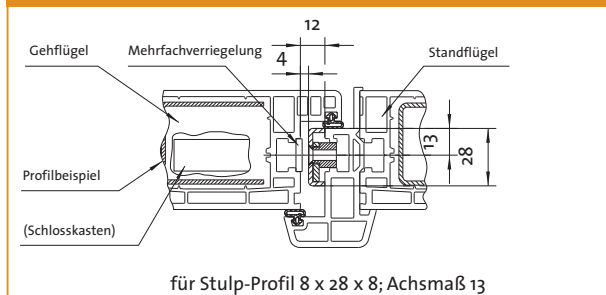
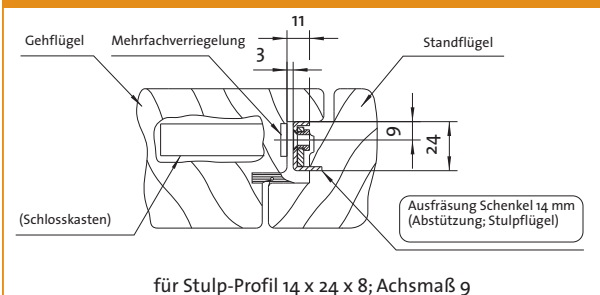
- der Stulpflügelbeschlag so montiert wird, dass ein Zwischenmaß von ca. 4 mm zwischen Schließbleitende des Stulpflügelbeschlages und des Schließbleches (Bodenbuchse) vorhanden ist (Abb. 2).
- der 14 mm lange Schenkel des Stulpflügelbeschlages so eingelassen wird, dass eine Schräglage und ein Wegkippen der Schließleiste nicht möglich und somit eine seitliche Abstützung für die Positionierung gewährleistet ist (Abb. 3-6).
- die skizzierte Positionslage des Stulpflügelbeschlages zur Mehrfachverriegelung gewährleistet ist (Abb. 1+2).
- die jeweiligen Artikelnummerzeichnungen für die Ausführungsvarianten der Stulpflügelbeschläge und deren dazugehörige Mehrfachverriegelungen beachtet werden.
- vor dem Einbau sämtliche Verunreinigungen, z. B. Späne aus den Fräsbereichen, entfernt werden.

Doppelflügel-Türen

AS 6000

Mehrfachverriegelung

* 7029 Umlenkgetriebe

* 7037-5 Eckwinkel

Verriegelung vertikal: 2 Bolzen
Ohne Falle und Riegel im Hauptschloss

Art. Nr.	Stulp	Maße
AS 6000 F 16		16 x 3 mm
AS 6000 F 20		20 x 3 mm
7029-20		20 x 3 mm
7037-5-20		20 x 3 mm

* separat bestellen

Entfernung	Dornmaß in mm													
 92	25	-	30	35	40	45	-	55	-	65	-	-	-	-

	8 mm
---	------

Varianten in mm					
		A	G	I	K
92 mm	Stand.	2100	1049	250	150

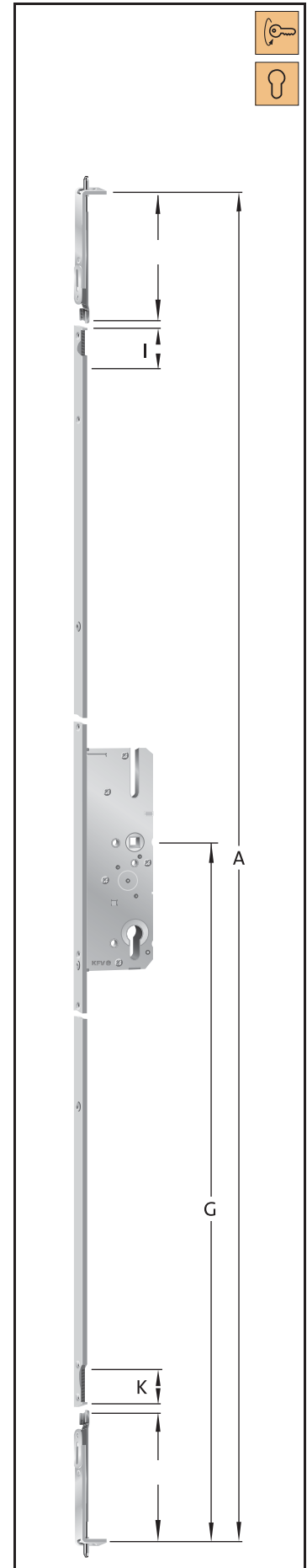

AS 6370

Mehrfachverriegelung

* 7029 Umlenkgetriebe



* 7037-5 Eckwinkel

Verriegelung horizontal: Hauptschloss und 2 Rundbolzen

Verriegelung vertikal: 2 Bolzen

Art. Nr.	Stulp	Maße
AS 6370 F 16		16 x 3 mm
7029-16		16 x 3 mm
7037-5-16		16 x 3 mm
AS 6370 F 20		20 x 3 mm
7029-20		20 x 3 mm
7037-5-20		20 x 3 mm

* separat bestellen

Entfernung	Dornmaß												in mm		
	92	-	-	-	35	40	45	-	55	-	65	-	-	-	-
		-	-	-	20	20	20	-	20	-	20	-	-	-	-
		8 mm, 10 mm													

Varianten in mm							
		A	B	C	G	I	K
92 mm	Stand.	2100	495	376	1049	250	150

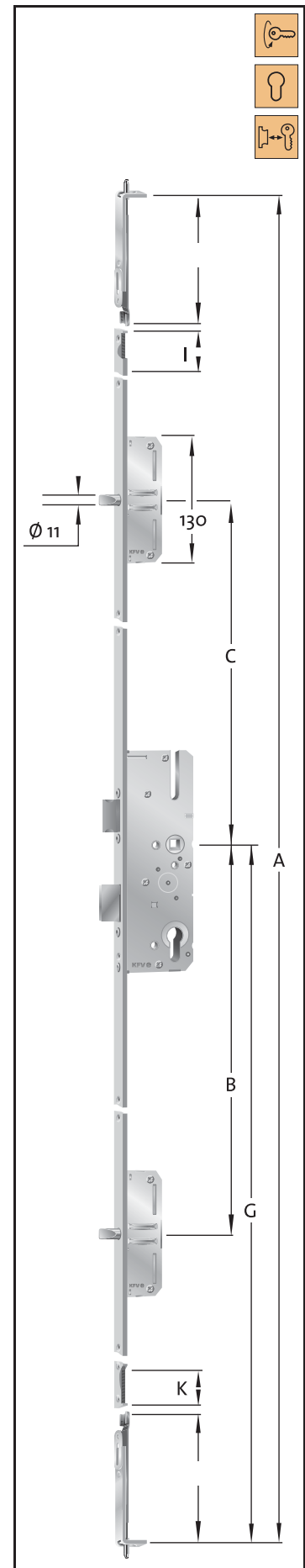

1

2

3

4

5

6

7

8



9

Klöntüren

AS 2300 B020

Bestehend aus 2 Verriegelungen; obere Verriegelung mit Wechsel
 Obere Verriegelung – B019 – Hauptschloss und Rundbolzen
 Untere Verriegelung – B018 – Hauptschloss und Rundbolzen

Art. Nr.	Stulp	Maße
AS 2300 B020 F 16		16 x 3 mm
AS 2300 B020 F 20		20 x 3 mm

Entfernung	Dornmaß													in mm			
	92	-	-	-	35	40	45	-	55	-	65	-	-	-	-	-	-
		-	-	-	20	20	20	-	20	-	20	-	-	-	-	-	-
		10 mm															

Varianten in mm							
		A	B	C	G	I	K
92 mm	B018	990	510	-	800	-	160
	B019	1120	-	355	250	385	-

Untere Verriegelung (B018): Der Riegel wird über den Profilzylinder ausgeschlossen, der untere Teil der Klöntür ist fest verschlossen. Der in der Abbildung dargestellte Nussvierkant bleibt ohne Funktion. In geöffnetem Zustand bei Zurückschließen des Riegels fährt ein Rundbolzen nach oben aus und verbindet die untere mit der oberen Verriegelung.

Obere Verriegelung (B019): Die obere Verriegelung wird wiederum über einen weiteren Profilzylinder verschlossen. Die Falle wird über den Nussvierkant betätigt. Der im geöffneten Zustand verbundene Flügel der oberen und unteren Verriegelung wird über den Drücker betätigt.

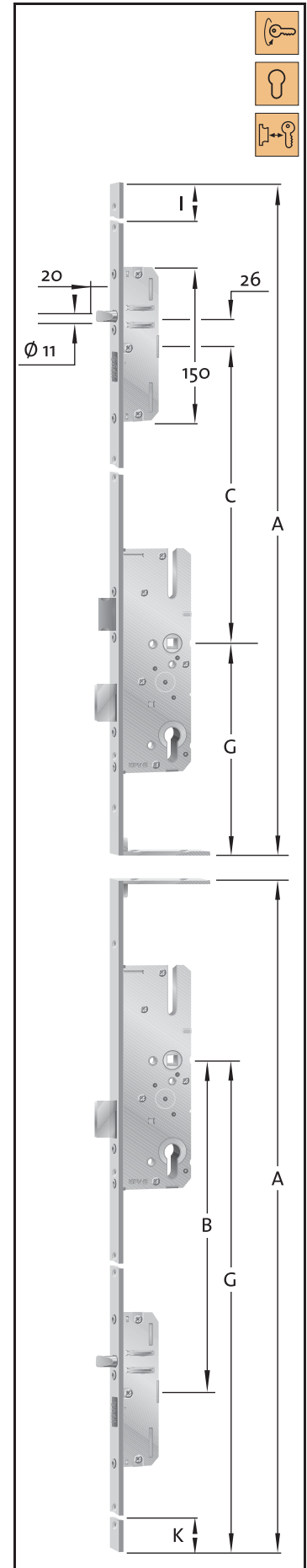

1

2

3

4

5

6

7

8

9

1

2

3

4

5

6

7



8

9

Stulpverlängerungen

V 2300

Anschlussstulp für hohe Türen mit Rundbolzen

Art. Nr.	Stulp	Maße
V 2300 F 16		16 x 3 mm
V 2300 F 20		20 x 3 mm
V 2300 F 24		24 x 3 mm
V 2300 P6/24		6 x 24 x 6 x 2 mm
V 2300 P8/24		8 x 24 x 8 x 2 mm Niro
V 2300 P10/24		10 x 24 x 10 x 2 mm Niro
V 2300 P10/30		10 x 30 x 10 x 2 mm

Varianten in mm

	A	G	I
	500	274	126

Anschlussstulp für hohe Türen
 Anschlussstulp V 2300 ist nur in Verbindung mit der Mehrfachverriegelung AS 2300
 Ausführung V001, V002, V003 und V004 einsetzbar.

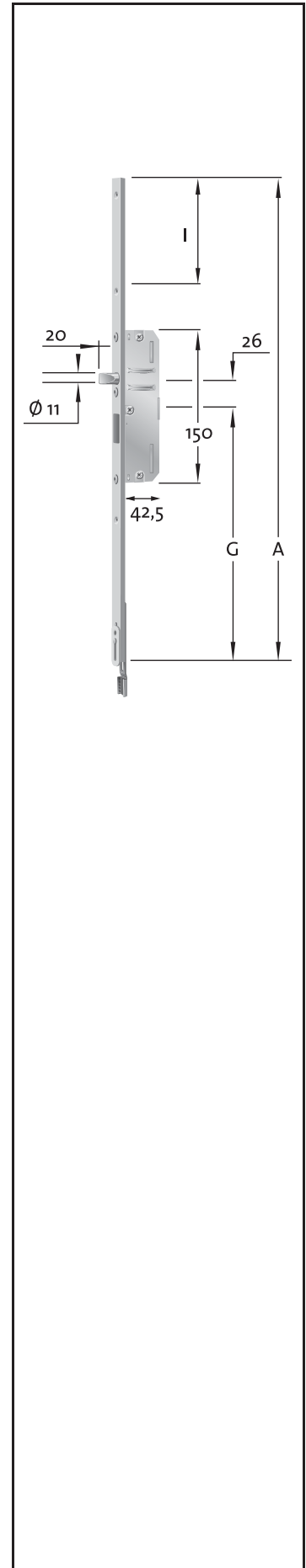

1

2

3

4

5

6



7



8

9

AS 2300 V001, V002, V003, V004

Mehrfachverriegelung für Anschlussstulp mit Rundbolzen

Art. Nr.	Stulp	Maße
AS 2300 V F 16		16 x 3 mm
AS 2300 V F 20		20 x 3 mm
AS 2300 V F 24		24 x 3 mm
AS 2300 V P6/22		6 x 22 x 6 x 2 mm
AS 2300 V P6/24		6 x 24 x 6 x 2 mm
AS 2300 V P8/22		8 x 22 x 8 x 2 mm Niro
AS 2300 V P8/24		8 x 24 x 8 x 2 mm Niro
AS 2300 V P10/24		10 x 24 x 10 x 2 mm Niro
AS 2300 V P10/30		10 x 30 x 10 x 2 mm

Entfernung	Dornmaß in mm													
 92	-	-	-	35	40	45	50	55	-	65	70	80	-	100
	-	-	-	20	20	20	20	20	-	20	20	20	-	20
	8 mm, 10 mm													

Varianten in mm							
		A	B	C	G	I	K
92 mm	V001	2100	760	730	1020	150	130
	V002	2100	760	730	1050	120	160
	V003	2350	760	980	1020	150	130
	V004	2350	760	980	1050	120	160

Stulpanschluss:

Darauf achten, dass alle Verriegelungselemente eingeschlossen sind. Verzahnte Treibstange der Mehrfachverriegelung – Ausführung V001 – in das Zahnsegment der Anschlussstulp einlegen. Halteplatte festschrauben. AS 2300, AS 2500 und AS 2600 in den Ausführungen V001, V002, V003 und V004 entsprechen den Ausführungen B001, B002, B003 und B004, jedoch vorgerichtet für Anschlussstulp (V2300, V2500 und V2600). Mehrfachverriegelung AS 9300 V001: Alle Maßangaben gelten auch für die Mehrfachverriegelung AS 9304 V001

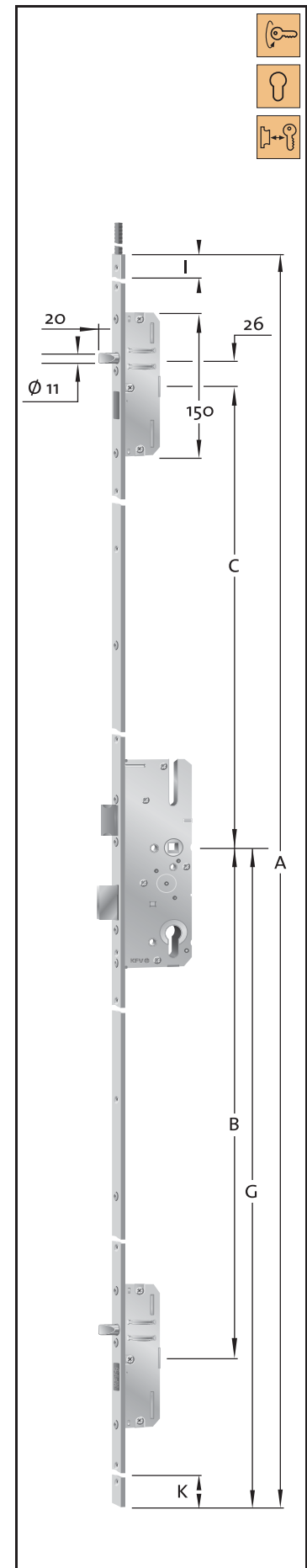

1

2

3

4

5

6

7



8

9

Stulpverlängerungen

V 2500

Anschlussstulp für hohe Türen mit Schwenkhaken

Art. Nr.	Stulp	Maße
V 2500 F 16		16 x 3 mm
V 2500 F 20		20 x 3 mm
V 2500 F 24		24 x 3 mm
V 2500 P 6/24		6 x 24 x 6 x 2 mm
V 2500 P 8/24		8 x 24 x 8 x 2 mm Niro
V 2500 P 10/24		10 x 24 x 10 x 2 mm Niro

Varianten in mm				
		A	G	I
		500	274	126

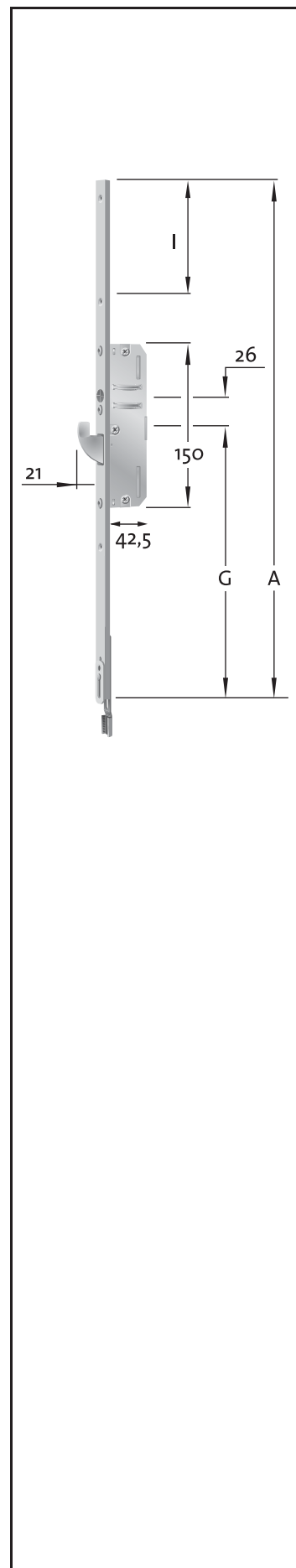

Anschlussstulp für hohe Türen
 Anschlussstulpen V 2500 und V 2600 sind nur in Verbindung mit den Mehrfachverriegelungen AS 2500 bzw. AS 2600 - Ausführung V001, V002, V003 und V004 - einsetzbar.







- 1
- 2
- 3
- 4
- 5
- 6
- 7
- 8
- 9

AS 2500 V001, V002, V003, V004

Mehrfachverriegelung für Anschlussstulp mit Schwenkhaken

Art. Nr.	Stulp	Maße
AS 2500 V F 16		16 x 3 mm
AS 2500 V F 20		20 x 3 mm
AS 2500 V F 24		24 x 3 mm
AS 2500 V P 6/22		6 x 22 x 6 x 2 mm
AS 2500 V P 6/24		6 x 24 x 6 x 2 mm

Entfernung	Dornmaß													in mm		
 92	-	-	-	35	40	45	50	55	-	65	70	80	-	100		
	-	-	-	20	20	20	20	20	-	20	20	20	-	20		
	8 mm, 10 mm															

Varianten in mm							
		A	B	C	G	I	K
92 mm	V001	2100	760	730	1020	150	130
	V002	2100	760	730	1050	120	160
	V003	2350	760	980	1020	150	130
	V004	2350	760	980	1050	120	160

Stulpanschluss:

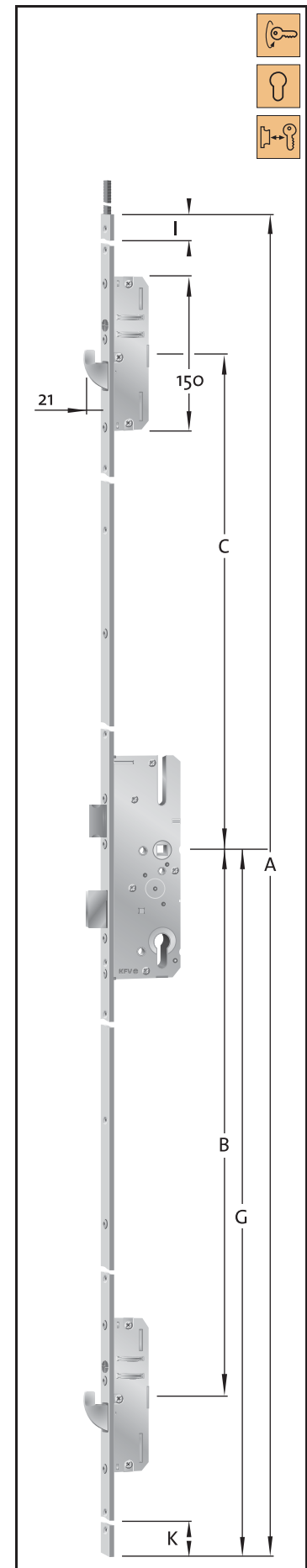

Darauf achten, dass alle Verriegelungselemente eingeschlossen sind. Verzahnte Treibstange der Mehrfachverriegelung – Ausführung V001 – in das Zahnsegment der Anschlussstulp einlegen. Halteplatte festschrauben.
 AS 2300, AS 2500 und AS 2600 in den Ausführungen V001, V002, V003 und V004 entsprechen den Ausführungen B001, B002, B003 und B004, jedoch vorgerichtet für Anschlussstulp (V2300, V2500 und V2600).
 Mehrfachverriegelung AS 9500 V001: Alle Maßangaben gelten auch für die Mehrfachverriegelung AS 9504 V001, 9600 V001 und 9606 V001.



Stulpverlängerungen

V 2600

Anschlussstulp für hohe Türen mit Bolzen-Schwenkhaken-Kombination

Art. Nr.	Stulp	Maße
V 2600 F 16		16 x 3 mm
V 2600 F 20		20 x 3 mm
V 2600 F 24		24 x 3 mm
V 2600 P 6/24		6 x 24 x 6 x 2 mm
V 2600 P 8/24		8 x 24 x 8 x 2 mm Niro
V 2600 P 10/24		10 x 24 x 10 x 2 mm Niro
V 2600 P 10/30		10 x 30 x 10 x 2 mm

Varianten in mm				
		A	G	I
		500	274	126

Anschlussstulpen für hohe Türen
 Anschlussstulpen V 2500 und V 2600 sind nur in Verbindung mit den Mehrfachverriegelungen AS 2500 bzw. AS 2600 - Ausführung V001, V002, V003 und V004 - einsetzbar.

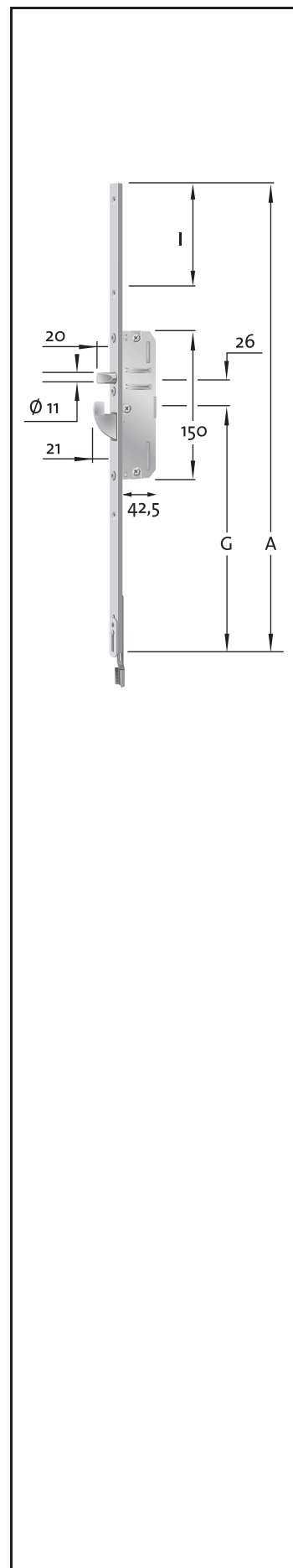

- 1
- 2
- 3
- 4
- 5
- 6
- 7
- 8
- 9

AS 2600 V001, V002, V003, V004

Mehrfachverriegelung für Anschlussstulp mit Bolzen-Schwenkhaken-Kombination

Art. Nr.	Stulp	Maße
AS 2600 V F 16		16 x 3 mm
AS 2600 V F 20		20 x 3 mm
AS 2600 V F 24		24 x 3 mm
AS 2600 V P 6/22		6 x 22 x 6 x 2 mm
AS 2600 V P 6/24		6 x 24 x 6 x 2 mm
AS 2600 V P 8/22		8 x 22 x 8 x 2 mm Niro
AS 2600 V P 8/24		8 x 24 x 8 x 2 mm Niro
AS 2600 V P 10/24		10 x 24 x 10 x 2 mm Niro
AS 2600 V P 10/30		10 x 30 x 10 x 2 mm

Entfernung	Dornmaß in mm														
	92	-	-	-	35	40	45	50	55	-	65	70	80	-	100
		-	-	-	20	20	20	20	20	-	20	20	20	-	20
		8 mm, 10 mm													

Varianten in mm							
		A	B	C	G	I	K
92 mm	V001	2100	760	730	1020	150	130
	V002	2100	760	730	1050	120	160
	V003	2350	760	980	1020	150	130
	V004	2350	760	980	1050	120	160

Stulpanschluss:

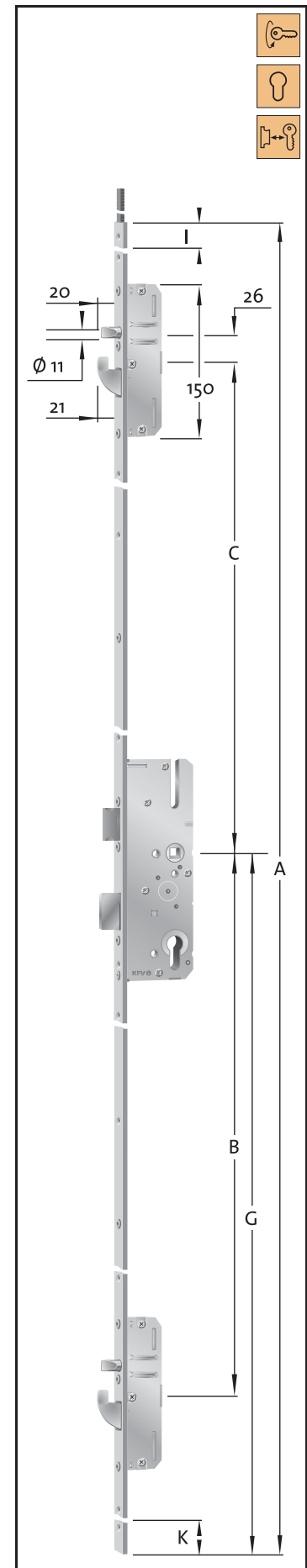

Darauf achten, dass alle Verriegelungselemente eingeschlossen sind. Verzahnte Treibstange der Mehrfachverriegelung – Ausführung V001 – in das Zahnsegment der Anschlussstulp einlegen. Halteplatte festschrauben. AS 2300, AS 2500 und AS 2600 in den Ausführungen V001, V002, V003 und V004 entsprechen den Ausführungen B001, B002, B003 und B004, jedoch vorgerichtet für Anschlussstulp (V2300, V2500 und V2600). Mehrfachverriegelung AS 9500 V001: Alle Maßangaben gelten auch für die Mehrfachverriegelung AS 9504 V001, 9600 V001 und 9606 V001.



Stulpverlängerungen

8035-45

Ausgleichstulpen für Stulpverlängerung, 400 mm lang

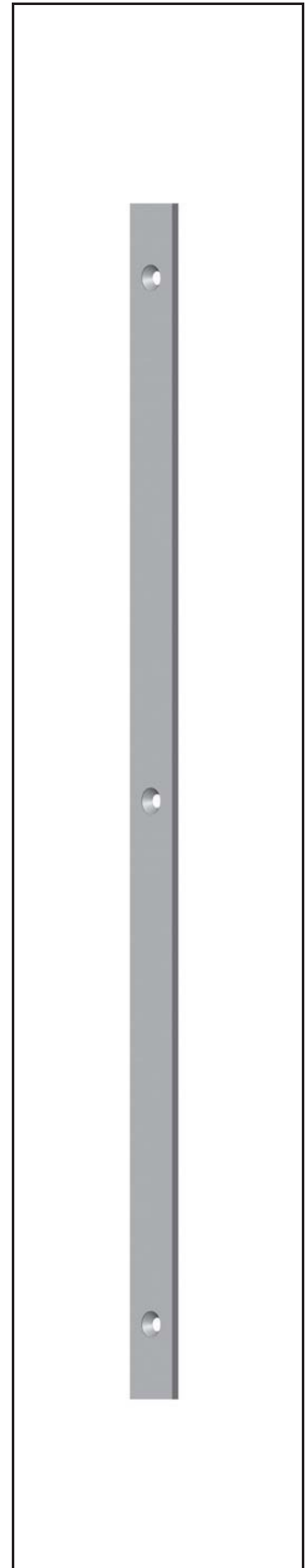

Art. Nr.	Stulp	Maße
8035-45 F 16		16 x 3 mm
8035-45 F 20		20 x 3 mm
8035-45 F 24		24 x 3 mm
8035-45 P 6/24		6 x 24 x 6 x 2 mm
8035-45 P 8/24		8 x 24 x 8 x 2 mm Niro
8035-45 P 10/24		10 x 24 x 10 x 2 mm Niro
8035-45 P 10/30		10 x 30 x 10 x 2 mm



1
2
3
4
5
6
7
8
9

8080

Anschlussstulp für hohe Türen
mit verstellbarem Schließzapfen

Art. Nr.	Stulp	Maße
8080 F 16		16 x 3 mm
8080 F 20		20 x 3 mm
8080 P 6/24		6 x 24 x 6 x 2 mm

Varianten in mm					
		A	B	C	K
		490	545	190	180

Anschlussstulpen für hohe Türen

Anschlussstulp 8080 ist in Verbindung mit allen Schließzapfen- bzw. Pilzzapfen - Mehrfachverriegelungen einsetzbar.

Stulp der Mehrfachverriegelung auf das angegebene Maß von 25 mm ab Mitte oberstem Anschraubloch kürzen. Treibstange der Anschlussstulp in die vorhandene Bohrung der Türverschlussstreibstange einhängen.

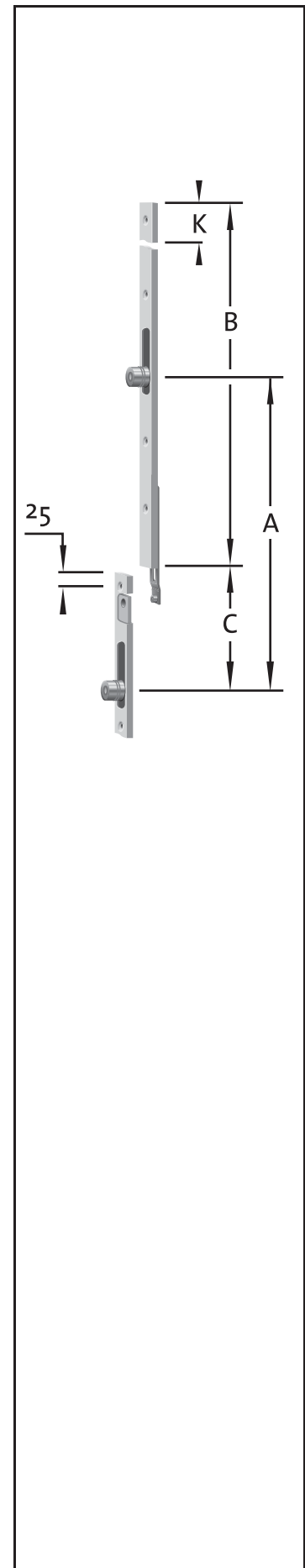

1

2

3

4

5

6



7



8

9

AS 4350

Mehrfachverriegelung mit Hauptschloss und 2 Rundbolzen

Art. Nr.	Stulp	Maße
AS 4350 F 16		16 x 3 mm
AS 4350 F 20		20 x 3 mm
AS 4350 P 6/24		6 x 24 x 6 x 2 mm

Entfernung	Dornmaß													in mm	
	92	25	-	30	35	40	45	-	55	-	65	-	-	-	-
		15	-	15	15	15	15	-	15	-	15	-	-	-	-
		8 mm													

Varianten in mm							
		A	B	C	G	I	K
92 mm	B001	2170	760	730	1020	290	130
	B298	2170	760	605	1020	415	130

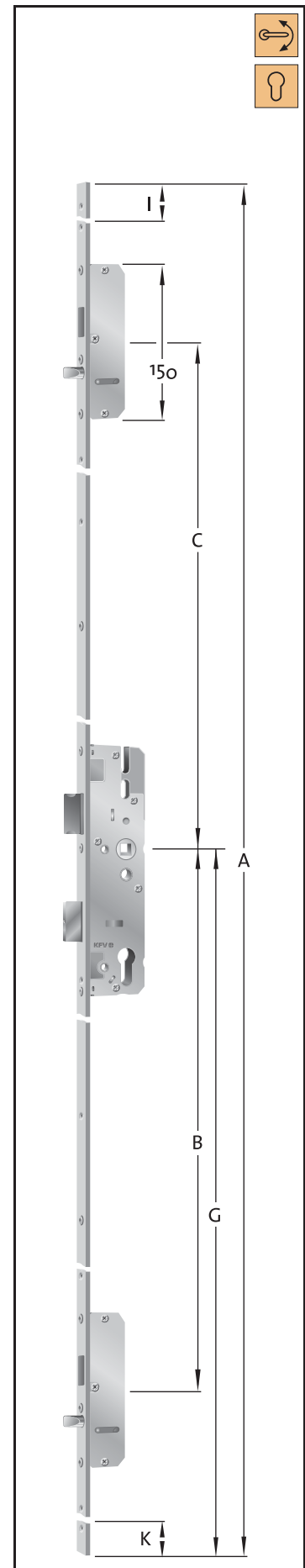





- 1
- 2
- 3
- 4
- 5
- 6
- 7
- 8
- 9

Außentüren – Schließzapfen

AS 4050

Mehrfachverriegelung mit Hauptschloss und 4 verstellbaren Schließzapfen

Art. Nr.	Stulp	Maße
AS 4050 F 16		16 x 3 mm
AS 4050 F 20		20 x 3 mm
AS 4050 P 6/24		6 x 24 x 6 x 2 mm

Entfernung	Dornmaß in mm													
	92	25	-	30	35	40	45	-	55	-	65	-	-	-
		15	-	15	15	15	15	-	15	-	15	-	-	-
		8 mm												

Varianten in mm										
		A	B	C	F	G	H	I	K	
92 mm	Stand.	2170	803	830	390	1020	280	260	137	

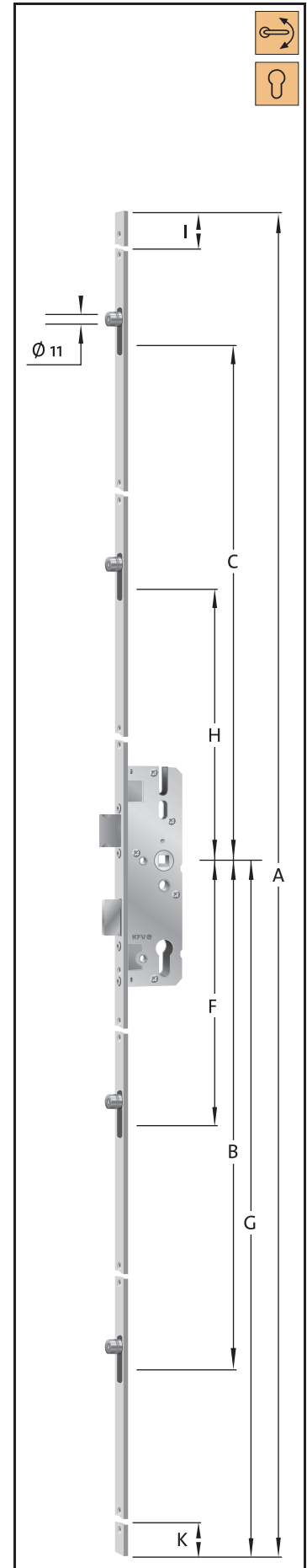

1
2
3
4
5
6
7
8
9

AS 7000

Mehrfachverriegelung

*7029 Umlenkgetriebe

*7037-5 Eckwinkel

Verriegelung vertikal: 2 Bolzen
Ohne Falle und Riegel im Hauptschloss

Art. Nr.	Stulp	Maße
AS 7000 F 16		16 x 3 mm
7029-16		16 x 3 mm
7037-5-16		16 x 3 mm
AS 7000 F 20		20 x 3 mm
7029-20		20 x 3 mm
7037-5-20		20 x 3 mm

*separat bestellen

Entfernung	Dornmaß in mm													
 92	25	-	30	35	40	45	-	55	-	65	-	-	-	-

	8 mm
---	------

Varianten in mm					
		A	G	I	K
92 mm	Stand.	2100	1049	250	150

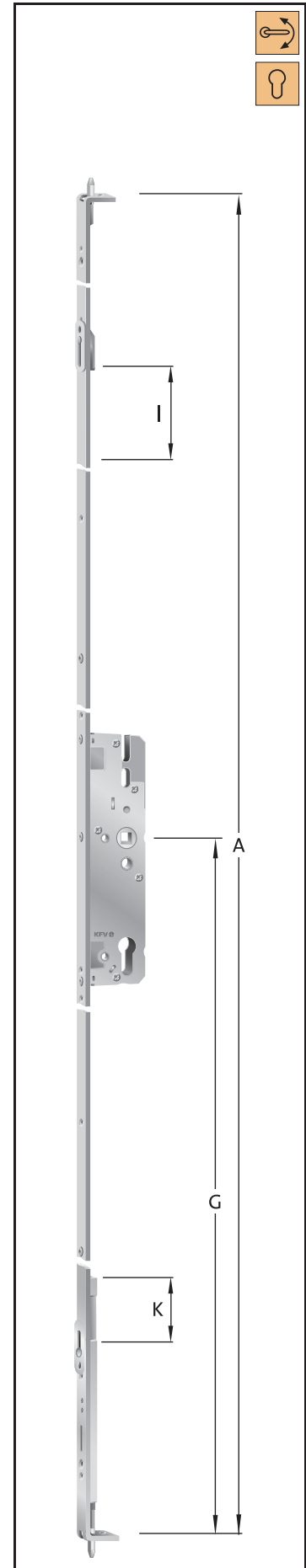

- 1
- 2
- 3
- 4
- 5
- 6
- 7
- 8
- 9

Doppelflügel-Türen – Rundbolzen

AS 7370

Mehrfachverriegelung

* 7029 Umlenkgetriebe

* 7037-5 Eckwinkel

Verriegelung horizontal: Hauptschloss und 2 Rundbolzen

Verriegelung vertikal: 2 Bolzen

Art. Nr.	Stulp	Maße
AS 7370 F 16		16 x 3 mm
7029-16		16 x 3 mm
7037-5-16		16 x 3 mm
AS 7370 F 20		20 x 3 mm
7029-20		20 x 3 mm
7037-5-20		20 x 3 mm

*separat bestellen

Entfernung	Dornmaß													in mm	
	92	25	-	30	35	40	45	-	55	-	65	-	-	-	-
		15	-	15	15	15	15	-	15	-	15	-	-	-	-
		8 mm													

Varianten in mm							
		A	B	C	G	I	K
92 mm	Stand.	2100	495	376	1049	250	150

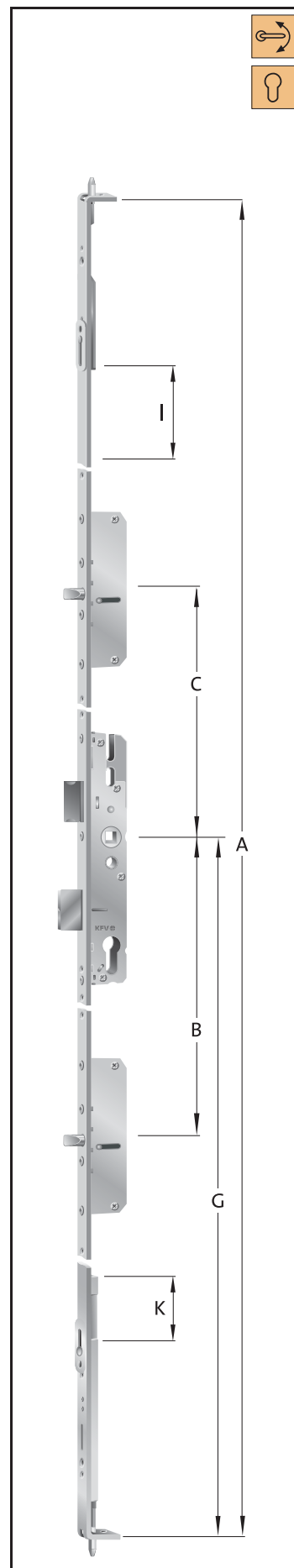

1
2
3
4
5
6
7
8
9

7033

Zwischenstück, 250 mm lang, Stulpverlängerung mit Boden- und Querrahmenverriegelung

Art. Nr.	Stulp	Maße
7033 F 16		16 x 3 mm
7033 F 20		20 x 3 mm

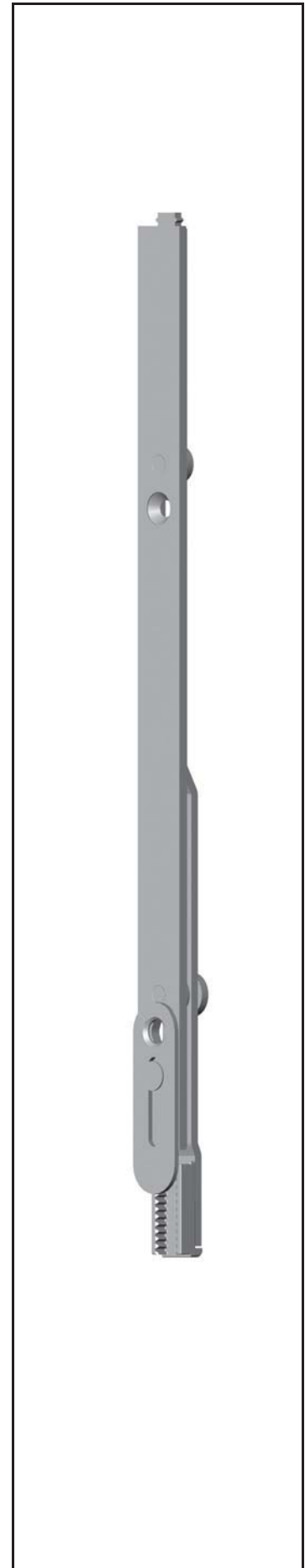



- 1
- 2
- 3
- 4
- 5
- 6
- 7
- 8
- 9

Stulpverlängerungen

V 4350

Anschlussstulp für hohe Türen mit Rundbolzen

Art. Nr.	Stulp	Maße
V4300 F 16		16 x 3 mm
V4300 F 20		20 x 3 mm
V4300 P 6/24		6 x 24 x 6 x 2 mm

Anschlussstulpen für hohe Türen

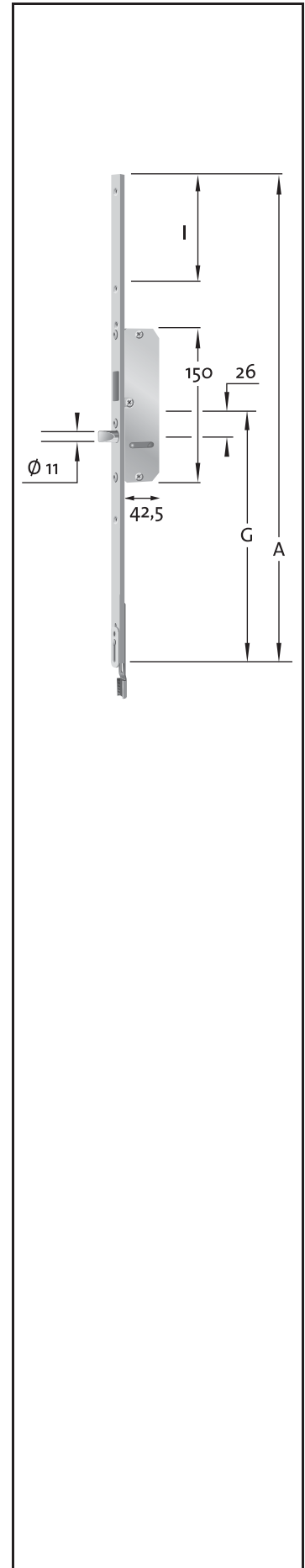

Anschlussstulp V 4300 ist nur in Verbindung mit der Mehrfachverriegelung AS 4350 Ausführung V001 einsetzbar.







- 1
- 2
- 3
- 4
- 5
- 6
- 7
- 8
- 9

AS 4350 V001

Mehrfachverriegelung für Anschlussstulp mit Rundbolzen

Art. Nr.	Stulp	Maße
AS 4350 V001 F 16		16 x 3 mm
AS 4350 V001 F 20		20 x 3 mm
AS 4350 V001 P 6/24		6 x 24 x 6 x 2 mm

Entfernung	Dornmaß													in mm	
	92	25	-	30	35	40	45	-	55	-	65	-	-	-	-
		15	-	15	15	15	15	-	15	-	15	-	-	-	-
		8 mm													

Varianten in mm							
		A	B	C	G	I	K
92 mm	B001	2170	760	730	1020	290	130
	B298	2170	760	605	1020	415	130

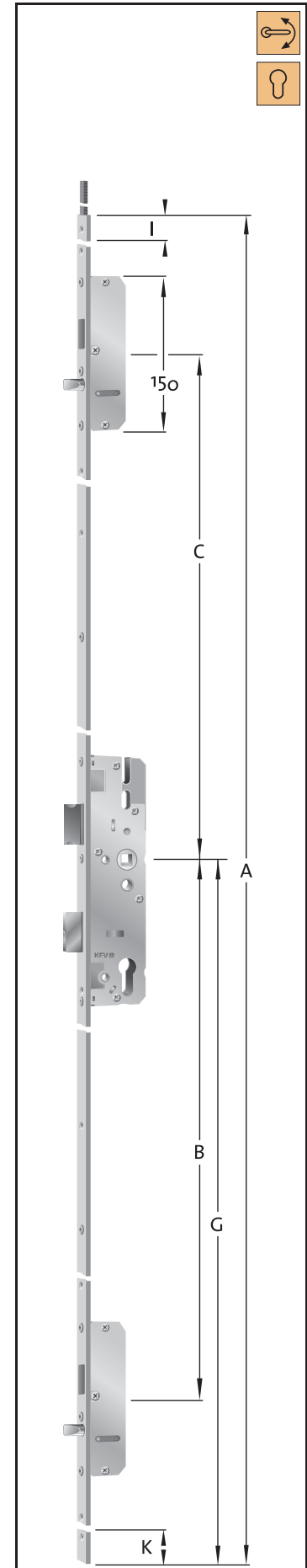

- 1
- 2
- 3
- 4
- 5
- 6
- 7
- 8
- 9